

THE
ANARCHIST

ARSENAL

IMPROVISED
INCENDIARY
AND
EXPLOSIVES
TECHNIQUES

DAVID HARBER

WARNING

The procedures in this manual and the resulting end-product are extremely dangerous. Whenever dealing with high explosives, special precautions should be followed in accordance with industry standards for experimentation and production of high explosives. Failure to strictly follow such industry standards may result in harm to life or limb.

Therefore, the author and publisher disclaim any liability from any damages or injuries of any type that a reader or user of information contained within this manual may encounter from the use of said information. Use this manual and any end-product or by-product at your own risk. This manual is for information purposes only.

THE ANARCHIST --- ARSENAL

IMPROVISED
INCENDIARY
AND
EXPLOSIVES
TECHNIQUES

DAVID HARBER

PALADIN PRESS
BOULDER, COLORADO

To my wife, Jackie, who put up with all those nights of weird and smelly experiments that went into this book, and who didn't even get excessively mad when I set the kitchen floor on fire.

Also by David Harber:

The Advanced Anarchist Arsenal

Recipes for Improvised Incendiaries and Explosives

Guerrilla's Arsenal

Advanced Techniques for Making Explosives and Time-Delay B

Improvised Land Mines

Their Employment and Destructive Capabilities

The Anarchist Arsenal:

Improvised Incendiary and Explosives Techniques

by David Harber

Copyright © 1990 by David Harber

ISBN 0-87364-580-4

Printed in the United States of America

Published by Paladin Press, a division of

Paladin Enterprises, Inc., P.O. Box 1307,

Boulder, Colorado 80306, USA.

(303) 443-7250

Direct inquires and/or orders to the above address.

All rights reserved. Except for use in a review, no portion of this book may be reproduced in any form without the express written permission of the publisher.

Neither the author nor the publisher assumes any responsibility for the use or misuse of information contained in this book.

C O N T E N T S

MOLOTOV COCKTAILS	1
A. The Ultimate Molly	
B. Gels for Molotov Cocktails	
C. Acid Delay Fuzes	
FIRE JAR	10
LUNCH BAG INCENDIARY	12
EXPLOSIVE FIREBOMB	15
FIRE LOGS	17
SAWDUST-DIESEL-NAPHTHALENE	
INCENDIARY	19
NITRIC ACID/NITROETHANE EXPLOSIVE	21
CONTACT EXPLOSIVES	22
LEAD AZIDE	25
RDX	28
LEWIS BOMB	31
FUEL-AIR EXPLOSIVES	33
A. 5-Gallon FAE	
B. 24-Gallon FAE	
C. 50-Gallon FAE	
D. Ether Bomb	
AUTOMOBILE BOMBS	43
A. Internal Automobile Bombs	
1. Coil Ignition Auto Bomb	
2. Starter Solenoid Auto Bomb	

3. Magnetic Auto Bomb	
4. Tilt-Fuzed Auto Bomb	
5. Thermal-Fused Auto Bomb	
6. Calcium Carbide Auto Bomb	
B. External Automatic Bombs	
1. Road Mines	
2. Culvert Mines	
3. Suicide Car Bombs	
LEAD-CREEP DELAY	69
SYRINGE FUZES	76
A. Electrical Version	
B. Land Mine Construction	
C. Chemical Version	
D. Time-Delay Syringe Fuze	
DIGITAL ELECTRONIC TIMERS	84
CAPILLARY FUZE	87
CLOTHESPIN SWITCH	89
CONCEALING EXPLOSIVES	94
NITRO NOTES	102
LIMPETRY	104

MOLOTOV COCKTAILS

The molotov cocktail, or "molly" as it is called by West German terrorists, is easily improvised and, if properly employed, effective against such diverse targets as offices, warehouses, motor vehicles, aircraft, or anything that burns or is damaged by heat (except tanks). Computers and other electronic equipment are especially vulnerable.

The basic molly consists of a fragile glass bottle containing gasoline or other combustible liquid and a rag stuffed in the top to act as a wick. To use, the rag is lit and the bottle hurled at the target. However, the basic design has some drawbacks that can be remedied with a few modifications. The first problem is that gasoline by itself tends to flash and burn out quickly. Adding an equal part of motor oil (used is fine) to the gasoline will result in a longer-lasting, hotter flame. The best consistency for the fuel is that of thin jelly rather than the firm butter paste of most flame fuel products. (Other fuels for mollies will be covered in the next section.)

The second drawback is that the rag may pop out when the molly is thrown, dousing the thrower with burning gasoline. This can be disconcerting to say the least. A much safer delivery system involves wedging a stick into the neck of the container to act as a plug, or wiring a tampon or similar cotton wick to the neck of a *sealed* bottle. To use, moisten the wick with fuel (lighter fluid is fine for this), light, and throw.

A trickier (but still solvable) problem with the rag ignition is that it leaves a burning trail back to the attackers (especially noticeable at night). Using an acid-ignition firebomb is one way to avoid this telltale problem. Fill a bottle with 1/4 *concentrated* sulfuric acid and 3/4 fuel. (Some fuels won't work because the

acid breaks down their gels, but the plain gas/oil mix seems to do well.) Cap the bottle tightly, rinse the exterior with water, and tape a small paper packet of 50/50 potassium chlorate and sugar mixture to each side. When the bottle breaks, the acid causes the ignitor mixture to burst into flames. In a pinch, you can tape several books of paper matches to the sides of the bottle.

A good tactic for using acid-ignition bombs that keeps your opponents on their toes is to place them in locations where the enemy is likely to pass and to rupture them with a rifle bullet at the appropriate time. Another successful tactic is to throw several unfuzed bottles of fuel to saturate the target and then ignite them with a lit bottle. As a low-cost harassment measure, West German "weekend terrorists" heave bricks, followed by a lit molly,

BASIC MOLLY

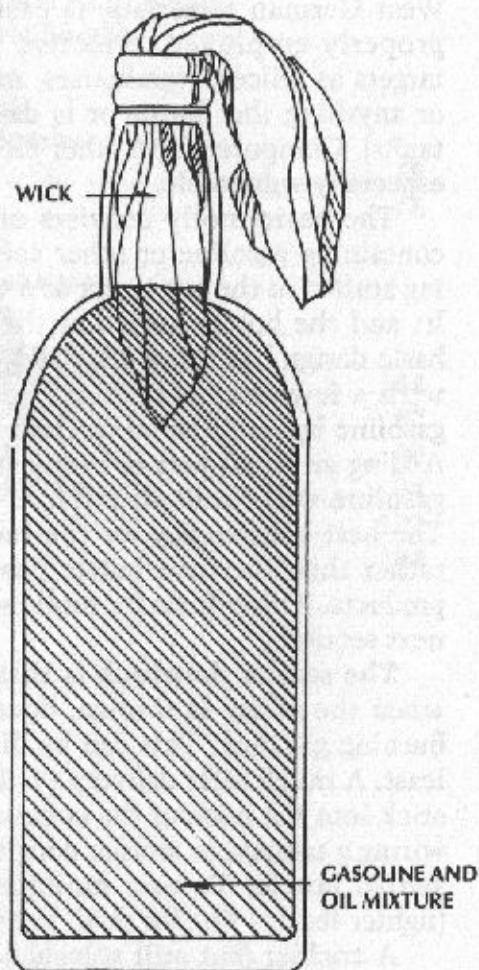

through the target's window.

Terrorists also use delay fuzes to avoid dousing themselves with fuel. A simple one uses glycerin and calcium hypochlorite (HTH), a common swimming pool chlorinator. Into a small wax-paper packet (about 1 1/2 inches square), pour 1 teaspoon of HTH and add a 000-gelatin capsule filled with glycerin. Seal the packet and tape it to the side of the firebomb. To use, squeeze the packet to crush the gelatin capsule and bring the glycerin into contact with the HTH. In 20 to 30 seconds, the packet will burst into flame and ignite the fuel. The firebomb can either be held until it becomes hot or thrown immediately. If the latter course of action is decided upon, the packet must be well sealed to prevent the fuel from entering and stopping the reaction. By itself, the gelatin ignitor is handy for simple harassing actions in offices, shops, or other sites. It can be squeezed and tossed into a handy wastepaper basket. The intense flame and cloud of chlorine smoke can also serve as a distraction to rivet people's attention on the trash can and away from some other area where the intended action is to occur.

The 1-liter molly seems to combine the best throw-weight/payload ratio. The burning power of anything smaller is usually inadequate, and anything larger is difficult to throw very far. Larger sizes, however, are ideal for dropping from buildings on targets. Any size that can be handled (a certain round, 5-gallon beer globe comes to mind) is fine. Plastic 1- or 2-liter soft drink bottles can be used if the plastic reinforcing ring on the bottom is removed. Simply fill the bottle with hot water to soften the adhesive and it will slip off easily. Test plastic containers to ensure that they will rupture on impact and that they are not made of one of the hydrocarbons, such as gasoline, that will dissolve.

THE ULTIMATE MOLLY

This device makes use of a phenomenon known as a flame-explosion couple. When ignited, it burns like a regular molly for a short period of time and then explodes with great violence. The mixture is composed of fuel, gellant, high explosive, and a primary explosive. As the fuel burns, the temperature and concentration of explosive in the mixture increase until detonation occurs, causing extensive damage to the target and throwing burning fuel over a wide area. The ultimate molly is safe to handle because it cannot be detonated by any means until the explosive content reaches a certain concentration.

Preparation

- 1) Add 15 parts (by weight) powdered high explosive to 80 parts gelled fuel (half fuel, half polystyrene, for instance).
- 2) Add 5 parts primary explosive (mercury fulminate, lead azide, etc.) and stir until well mixed. A 1-quart bottle holds about 800 grams of this mixture. If you have access to plastic explosives, an excellent ratio is 40 parts gasoline and 40 parts C-4. Stir until a smooth mix is obtained, then pop in two nonelectric blasting caps. The polyisobutylene in the C-4 helps to gel the fuel.

This mixture is quite spectacular in action and can cause a lot of damage, but it wastes primary explosive. Two blasting caps can be used if the raw primary is not available, but the delay is shorter. The primary is the best way to go. (If picric acid is used as the high-explosive component, you may not need primary.) Picric acid explodes after 5 seconds at 250 degrees Celsius in its pure form. In this device, it should go off in less than 2 minutes.

The ultimate molly is not for everyday use, certainly, but it does the trick for those targets that deserve a little something extra.

GELS FOR MOLOTOV COCKTAILS

Suitable, available fuels for molliques include gasoline, kerosene, diesel fuel, and paint thinner. Kerosene has the highest fuel value and is most effective, but gasoline is cheaper and more readily available. Any liquid fuel that burns will work, but if it is not a petroleum-based fuel, it can be difficult to gel. Diesel is also difficult to gel. The following mixtures have been field-tested in molliques and work well. All of the formulas are for a 1-quart bottle.

Soap Gel

- 1) Pour 1/2 cup of soap flakes or powder (*not* dishwashing detergent) into a bottle.
- 2) Add fuel until the level reaches just below the neck.
- 3) Add 1/2 teaspoon of alcohol.
- 4) Periodically stir briskly until the gel forms.

Lye Gel

- 1) Pour 3 1/2 cups of fuel into a bottle.
- 2) Add 2 teaspoons of castor oil and stir until dissolved.
- 3) Add 1/2 teaspoon alcohol to the mixture.
- 4) In a large plastic measuring spoon, dissolve 1/4 teaspoon of lye flakes in an equal amount of water. If lye powder is used, halve these amounts.
- 5) Add the lye slurry to the bottle and stir occasionally for about 30 minutes until it thickens. In 1 to 2 days the mixture will thicken to a soft jell-like consistency, similar to that of thick honey.

Egg Gel

- 1) Add 3 1/2 cups of fuel to the bottle.
- 2) Add 2 egg whites. Separate the eggs carefully to

avoid getting yolk mixed in with the whites. If this happens, discard the eggs and try again.

- 3) Add 1 teaspoon of table salt and stir until the gel forms, usually within 5 to 10 minutes. This mix should be used within 24 hours, as the gel is only stable for that length of time. If desired, finely powdered charcoal or flour can be used to fill the remainder of the bottle. This addition greatly enhances the incendiary effect of any gelled fuel. It can be used in a concentration of up to 40 percent by weight or volume. In the higher concentrations, the mixture congeals into a wet, granular solid that has a high incendiary value but is unsuited for use in molliques.

Napalm B

Napalm B was developed by Dow Chemical during the Vietnam War as a replacement for the original napalm jelly in firebombs. It is stickier and burns much hotter than the original filler. The Dow formula used 25 percent gasoline, 25 percent benzene, and 50 percent polystyrene. Polystyrene is a common plastic used for such diverse items as toys, styrofoam cups, and packing-filler "peanuts." As anyone who has tried to spray-paint a styrofoam cooler knows, polystyrene dissolves into a sticky mush when it comes in contact with hydrocarbons such as paint or gasoline. It is this quality of polystyrene that makes napalm B so effective for molotov cocktails.

Any form of polystyrene will work, but more solid forms take longer to dissolve. Styrofoam cups or packing peanuts dissolve faster because of their lower densities. Unfortunately, the air pockets in their structure take up space, which means that it takes a lot longer to produce.

The following recipe works for styrofoam cups or peanuts:

- 1) Fill bottle half-full of fuel.
- 2) Fill remainder of bottle with small pieces of styrofoam cup or peanuts.
- 3) Cap and shake for 1 minute.
- 4) The styrofoam pieces should have dissolved. If not, continue shaking until they do. Repeat steps 2 and 3 until bottle is completely full.

ACID DELAY FUZES

Sometimes a longer delay is required than the HTH/glycerin or HTH/brake-fluid fuzes can supply. Most of the acid/chlorate systems are too unwieldy or complicated for quick, surreptitious use. The 2 acid delay fuzes I have devised are small and can be activated by crushing them between two fingers.

A small vial of sulphuric acid is enclosed in a barrier material. The vial must be of a thin, fragile glass that can be easily crushed. A small tubular light bulb or a small smelling-salts vial, carefully opened and resealed, is perfect for this. Care must be taken when resealing to make sure the vial doesn't leak. The hole should be as small as possible and can be sealed with wax, which is impervious to sulphuric acid. Small 1- or 2-milliliter glass vials are available at some "head" shops that sell drug paraphernalia. They are about 1 inch long by 1/4 inch in diameter and are sealed with a cork. This cork should be coated with wax to protect it from the acid. The vials can also be made by sealing the ends of a short length of glass tube with wax or epoxy putty.

Acid Delay Fuze Type A

- 1) Prepare acid vial as described above.
- 2) Cut off a piece of plastic drinking straw approximately twice the length of the vial. Make sure the diameter of the straw is big enough to accommodate the vial.

- 3) Pinch one end of the straw shut and seal it with epoxy or by using the edge of a hot knife blade to melt the plastic.
- 4) Drop sealed acid vial into the straw.
- 5) Seal open end of straw as described in step 3.

To use, place the completed straw into a small packet of potassium chlorate/sugar mixture. When ready to start delay, crush the vial between the fingers. In about 15 minutes (depending on the temperature and the thickness of the straw), the device will ignite.

Acid Delay Fuze Type B

- 1) Prepare acid vial as above.
- 2) Prepare a small length of plastic straw the same size as the vial. Slide the vial into the length of straw. This protects the balloon from punctures when the vial is crushed.
- 3) Slip the straw into a small rubber balloon and knot it. To use, follow directions for Type A.

ACID-DELAY FUZES

TYPE A

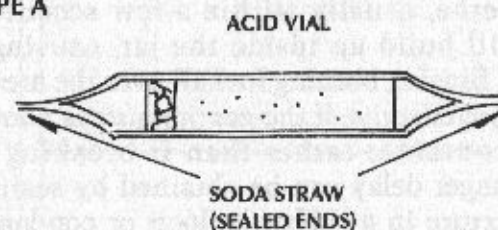

TYPE B



FIRE JAR

This device is ideal for placing behind doors, in stairwells, or in other spots where it is likely to be tipped over accidentally.

Attach a packet of potassium chlorate/sugar to the inside lid of a wide-mouth jar, add fuel and acid to the jar, and tighten the lid. When the jar is turned over, the lower acid layer comes into contact with the chlorate mixture, and ignition occurs within a few seconds. To construct:

- 1) Wrap ignition materials in a thin, plastic sandwich bag.
- 2) Tape or glue bag securely to the inside of the lid.
- 3) Fill jar 1/4 full of concentrated sulphuric acid.
- 4) Fill the jar to 3/4 level with fuel.
- 5) Cap jar tightly. Make sure bag does not contact liquid.

To use, invert jar or place in an area where this is likely to occur. Upon inversion, the liquid will begin to boil and seethe, usually within a few seconds. Gas pressure will build up inside the jar, causing it to explode and flinging burning fuel all over the area. This device is more effective if the gas pressure is allowed to burst the container rather than it breaking when tipped. A longer delay can be obtained by sealing the chlorate mixture in a rubber balloon or condom. The balloon will provide about 15 minutes' delay, while the condom will provide about 5 minutes. Use caution when handling the balloon or condom because gasoline will seriously weaken the rubber membrane, possibly causing misfire or premature ignition.

FIRE JAR

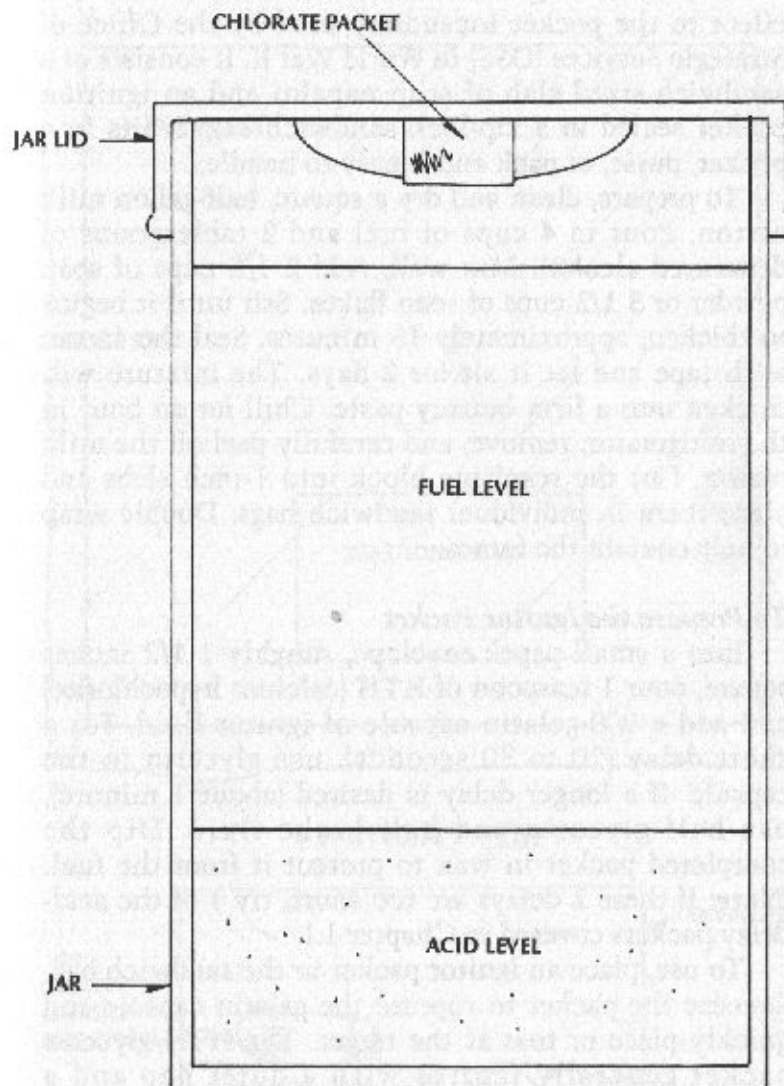

LUNCH BAG INCENDIARY

The lunch bag incendiary is similar in size and effect to the pocket incendiary used by the Office of Strategic Services (OSS) in World War II. It consists of a sandwich-sized slab of soap napalm and an ignition packet sealed in a zip-lock sandwich bag. It fits in a pocket, purse, or pack and is easy to handle.

To prepare, clean and dry a square, half-gallon milk carton. Pour in 4 cups of fuel and 2 tablespoons of denatured alcohol. Mix well. Add 2 1/2 cups of soap powder or 3 1/2 cups of soap flakes. Stir until it begins to thicken, approximately 15 minutes. Seal the carton with tape and let it sit for 2 days. The mixture will thicken into a firm buttery paste. Chill for an hour in the refrigerator, remove, and carefully peel off the milk carton. Cut the resulting block into 1-inch slabs and place them in individual sandwich bags. Double wrap to help contain the fumes.

To Prepare the Ignitor Packet

Into a small paper envelope, roughly 1 1/2 inches square, pour 1 teaspoon of HTH (calcium hypochlorite) and add a 000-gelatin capsule of ignitor fluid. For a short delay (20 to 30 seconds), use glycerin in the capsule. If a longer delay is desired (about 1 minute), use half glycerin and half brake fluid. Dip the completed packet in wax to protect it from the fuel. [Note: If these 2 delays are too short, try 1 of the acid-delay packets covered in Chapter 1.]

To use, place an ignitor packet in the sandwich bag. Squeeze the packet to rupture the gelatin capsule and quickly place or toss at the target. The HTH/glycerin packet generally ignites with a quiet pop and a crackling flame about 4 inches high. Although this is fine for this application, it is sometimes desirable to

LUNCH BAG INCENDIARY

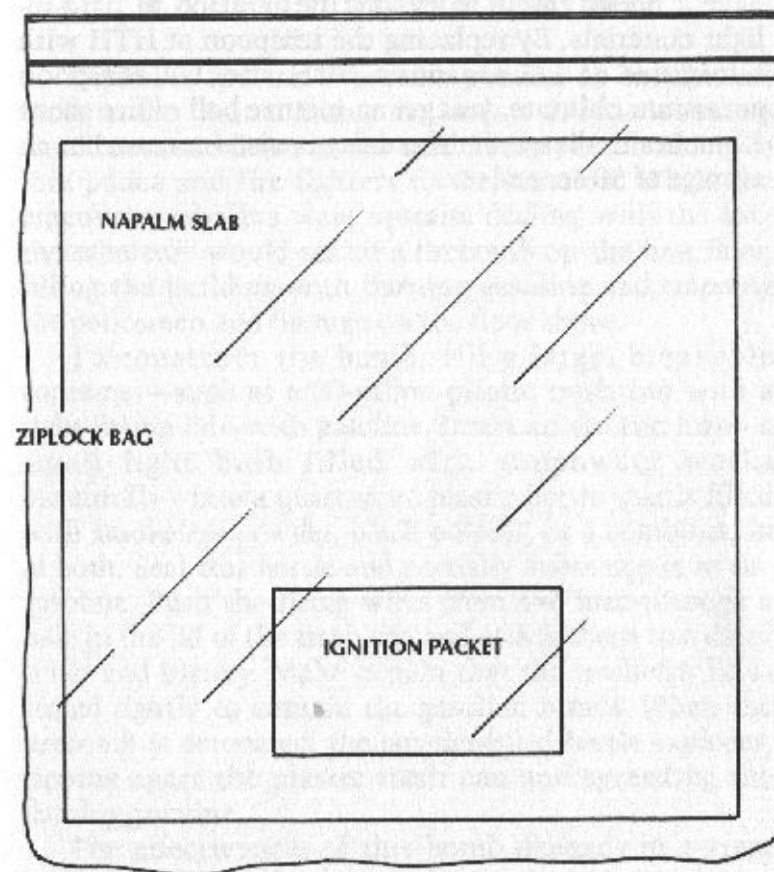

IGNITION PACKET

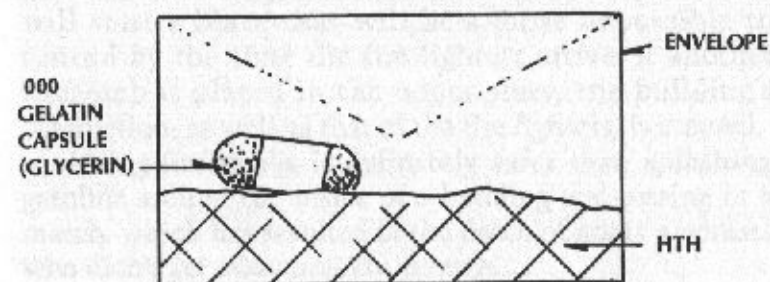

have a hotter flame to ensure the ignition of hard-to-light materials. By replacing the teaspoon of HTH with a mixture of 1/2 teaspoon HTH and 1/2 teaspoon potassium chlorate, you get an intense ball of fire about 12 inches in diameter. The delay is also increased to an average of 50 seconds.

EXPLOSIVE FIREBOMB

Explosive firebombs became popular as entrapment tools in the United States in the late 1960s. Saboteurs would set a small fire on the second story of a building to lure police and fire fighters to the location. While the emergency workers were upstairs dealing with the fire, the saboteurs would set off a firebomb on the first floor, filling the building with burning gasoline and trapping the policemen and firemen on the floor above.

To construct the bomb, fill a large, breakable container—such as a 20-gallon plastic trash can with a tight-fitting lid—with gasoline. Insert an electric fuze—a small light bulb filled with gunpowder works beautifully—into a quart-sized plastic bottle that is filled with smokeless powder, black powder, or a combination of both. Seal this bottle and partially submerge it in the gasoline. Push the firing wires from the fuze through a hole in the lid of the trash can and attach them to a delay timer and battery. Make certain that the trash-can lid is sealed tightly to contain the gasoline fumes. When the firebomb is detonated, the powder-filled bottle explodes, ripping apart the plastic trash can and spreading the flaming gasoline.

The effectiveness of this bomb depends to a great extent upon its placement. It should be placed in a somewhat central location from which it can flood the area with burning gasoline. One or two of these devices will start a blaze that will be almost impossible to control by the time the fire fighters arrive. If another firebomb is placed in the upper story, the building's destruction, as well as that of the fire fighters, is assured.

Using firebombs is definitely safer than splashing gasoline around the inside of a building and tossing in a match, which has resulted in the death of many arsonists who didn't get away quickly enough.

EXPLOSIVE FIREBOMB

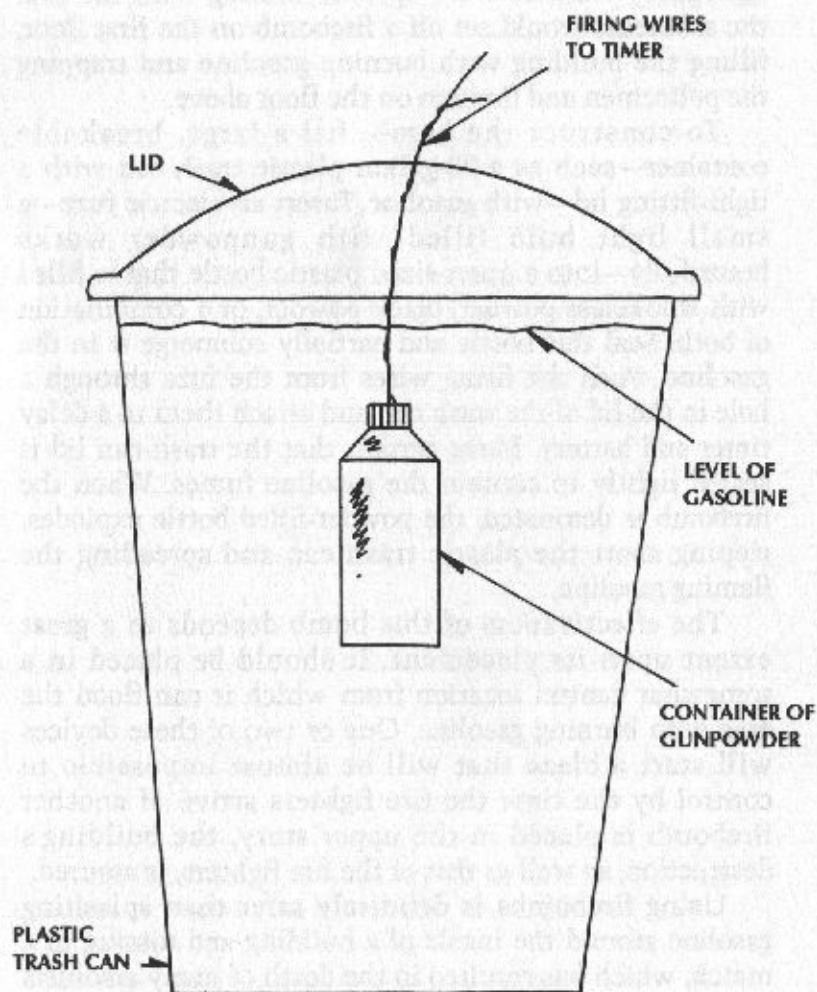

FIRE LOGS

It is well known that wax mixed with sawdust makes a fine incendiary. It is not as well known that commercially available pressed-wood "fire logs" are composed of exactly the same materials and can be easily modified for use as incendiaries. Buy the cheapest ones available. The only differences between them are the chemicals that the high-priced ones have to make their flames prettier and the type of wood used (some use cedar for fragrance). For incendiary purposes, how the fire looks or smells is of no consequence.

The logs generally come in 3- to 6-pound sizes. Remove the wrapper and saw them into 1-pound chunks. They saw easily, rather like cutting a large Tootsie Roll. Place each chunk in a paper lunch sack and heat in a microwave oven for 3 to 5 minutes on 50 percent power (defrost setting) until the log breaks apart. Time will vary with different ovens. If a microwave is not available, heat a regular oven to 250 degrees for 10 minutes, then turn it off. Place 1 sack at a time in the oven and warm until the log can be easily broken apart, generally about 10 minutes. Watch the sack carefully and remove it from oven if it begins to smoke. Break up the chunk until it forms a loose, coarse mixture resembling manure fertilizer. It may be easier to spread the chunks on a sheet of newspaper and break them apart with a fork.

While the sawdust is still warm, 1/2 cup of powdered charcoal or flour may be added to increase its incendiary effect. Just add the powdered material to the warm mix and shake the bag. It is now ready to use. The bag can be lit with a match or delay ignitor. It will burn slowly at first, then faster, with an increasingly hot flame. Unless a large amount of raw wax and sawdust are available, commercial fire logs are the way

to go. Even top-of-the-line logs cost less than 50 cents a pound and are much easier to fashion into explosives. The fire logs are common, innocuous, and may be purchased without question or comment, especially during fall and winter.

SAWDUST-DIESEL-NAPHTHALENE INCENDIARY

Pound for pound, this is the best of the easily improvised incendiaries. It costs about a dollar a pound to produce, is easy to make, and burns extremely hot with a large flame. Its only drawback is that naphthalene has a pronounced, distinctive smell before and after burning, so this incendiary must be well sealed to prevent detection and should not be used in "accidental" fires. To increase the rate of burning, a handful of ammonium nitrate (a common, inexpensive agricultural or gardening fertilizer) can be added before bagging. If ammonium nitrate is added, the material should not be tested in a fireplace. This addition increases the output of noxious fumes, thus creating a possible health hazard. Otherwise, up to 1 pound of the sawdust-diesel-naphthalene mixture can be tested indoors.

To make, place a 1-pound chunk of commercial pressed-wood fire log in a microwave and heat for about 3 1/2 minutes (at defrost). Remove and break the chunk apart with a fork. Pour the resulting loose mixture into a 3-pound coffee can and add a 1-pound box of naphthalene moth crystals. (If for some reason moth balls must be used, they should be soaked in a little diesel for a week or so, which will dissolve them.) Put the lid on the can and shake to mix. Pour in diesel fuel until the mixture is well soaked. Do not use too much diesel—about a quart is usually fine, but this may vary. Stir until evenly mixed. Let it sit for a couple of days and stir again. The naphthalene should be dissolved. It is now ready to use.

To use, scoop the mush into a quart-sized zip-lock storage bag until it is almost full. Seal this and place in a paper lunch sack. Add a fuze packet and place on or

in the target. Activate the fuze and vacate the area. This mix will burn slowly until the flame reaches the plastic bag and heats it up. If it is necessary or desirable, the bag may be safely lit with a match. You have about 2 or 3 minutes before it *really* starts burning.

NITRIC ACID/NITROETHANE EXPLOSIVE

It is fairly well known that highly concentrated nitric acid (95+ percent) can be used in conjunction with various materials to form a simple but powerful 2-component high explosive. Highly concentrated nitric acid, however, is not commercially available in many areas and is expensive where it is. The following mixture uses 70 percent nitric acid, which is the most widely available strength.

Nitroethane is a common industrial solvent that is quite cheap in bulk. It is also safer to use and store than most other solvents, including acetone. It can be detonated by a #8 blasting cap. Because of the corrosive nature of nitric acid, the blasting cap and wires should be coated with wax or acid-resistant epoxy paint. This mixture, although not overly sensitive, should still be handled with care. Adding the nitroethane to the nitric acid at the blasting area provides maximum safety because nitric acid is not an explosive until this is done. When priming be sure the blasting cap is centered in the liquid. The detonating velocity of this explosive is 6,645 meters per second, roughly equivalent in power to TNT. A 1-pound charge is prepared as follows.

- 1) Pour 219 milliliters (310 grams) of 70 percent nitric acid into a 1-pint acid-resistant container.
- 2) Add 144 grams of nitroethane.
- 3) Prime and seal with wax or other acid-resistant material.
- 4) Blast.

CONTACT EXPLOSIVES

These are loud and highly sensitive explosives. A dust-sized particle will make a sharp crack or popping sound. A piece the size of a pencil lead will produce an explosion as loud as any of the largest firecrackers or cherry bombs. It is perfectly safe to handle and apply when wet because it cannot be exploded by any means when it is wet. When it dries, it will explode at the touch of a feather.

Granular Explosive

1. Crush enough iodine crystals to make a pile of powder equal to the volume of a pencil eraser (do not grind into a fine powder).
2. Pour about 4 ounces or 1/2 measuring cup of strong ammonia water into a pint-sized glass jar.
3. To this add the iodine powder and let sit for about 5 to 10 minutes, shaking frequently.
4. While the mixture is reacting, make a filter paper cone out of 2 newspaper sheets. This can be done by laying the sheets together for strength, folding them in half, then folding double again at a right angle to the first fold. Crease the folds all the way down to—but not including—the corner where they meet. Tear out a semicircle using the corner as a center with an 8-inch radius. Pull out the 2 sheets from the side to form a cone.
5. Let the iodine mixture sit long enough for the sediment to settle and discard as much of the clear liquid as possible before filtering the sediment. Hold the filter cone over a clean, wide-mouthed, 1-quart glass jar and pour the liquid containing the sediment into it. The sediment is your explosive. The small amount you have just made will go much farther than you realize.

6. Place the explosive in an airtight, leakproof pill bottle. Because this explosive is unstable by nature when it dries, it should be stored and applied while wet.

Paint-Type Explosive

1. Make up a strong tincture of iodine using about 4 ounces or 1/2 measuring cup of wood alcohol (if wood alcohol is unavailable, denatured or rubbing alcohol can be used).
2. Add iodine crystals and shake thoroughly until no more will dissolve. Pour the liquid into a clean, 1-quart, wide-mouthed jar.
3. Gradually add ammonia water and stir until the mixture is chocolate brown and shows little of the original color of the iodine. The amount of ammonia necessary will depend on its strength. An equal volume of ammonia, 4 ounces, is usually sufficient for a 15 percent or higher solution.
4. Filter the solution at once, if possible, but certainly within 10 to 15 minutes.
5. Store in an airtight pill bottle. The explosive should be stored and applied while wet.

Care in Handling and Storage

Contact explosives may be stored in the freezer for months without deteriorating in strength. The bottle should be recapped tightly after use and the bottle mouth wiped clean. This explosive can cause dark stains to rugs, clothing, chair seats, wallpaper, and light or clear plastics. A strong solution of sodium thiosulphate is effective for removing the stains from hands and clothing before they set. It is inexpensive and can be found at local drugstores. Leaving the bottle of explosive in direct sunlight for more than a few minutes will weaken it. **Warning:** Do not attempt to make a large explosion as it can cause deafness.

Application

Although largely a scientific curiosity, contact explosive is well suited for practical jokes. It can be painted or sprinkled on light switches, floors, keyholes, pencil sharpeners, doorknobs, and in hundreds of other places. It is also ideal for catching locker thieves and desk prowlers, since the noise from the explosion will attract immediate attention and the explosive will leave a dark stain on the intruder's hands when it explodes.

Note: The majority of drugstores no longer carry the chemicals needed for this explosive, but they are available at most chemical supply houses, and some gun shops sell 28 percent ammonia, which is used in combination with commercial powder solvent to remove copper fouling from rifle barrels (incidentally, it works great for this). Also be sure you have adequate ventilation when making this explosive. Concentrated ammonia has an intense smell that can be overpowering. Never take a deep whiff of ammonia. I burned my sinuses badly taking a close sniff from a bottle of barrel cleaner I had made, checking to see if the ammonia was still strong enough to do the job. Ten minutes later, when my eyes stopped tearing and my nose stopped burning, I decided it was. My sinuses bothered me for months.

LEAD AZIDE

Lead azide is the standard detonating material used in military blasting caps and other fuzing systems. Although slightly less efficient than the old standby, mercury fulminate, it has a much longer storage life over a wider range of temperatures. It is also cheaper and easier to make. Its main drawback is that the two main chemicals used in its production, sodium azide and lead nitrate, have to be obtained from a chemical supply house. Lead nitrate is comparatively cheap, about seven dollars a pound at the time of this writing. Sodium azide is more expensive, about twenty-five dollars for 100 grams. This may seem expensive, but 100 grams of sodium azide will produce 200 grams of lead azide, enough for 500 detonators if they are designed properly. If you add a one-gram RDX or PETN booster, you get a detonator equal in power to the special J-2 military cap. And this is for a total cash outlay for chemicals of less than seventy-five dollars, including those needed to make the RDX or PETN base charge.

Warning: Lead azide should *never* be used in brass or copper shells. Contact with either of these 2 metals could cause the formation of supersensitive copper azide crystals, which can explode if you so much as speak harshly to them. It might be necessary to use an easily ignited flash or cover charge over the lead azide because it has a higher ignition temperature than mercury fulminate. A small amount (about one grain) of a simple potassium chlorate/sugar paste is fine for this.

Production

Prepare the following two solutions in separate containers.

LEAD-AZIDE PRODUCTION SETUP

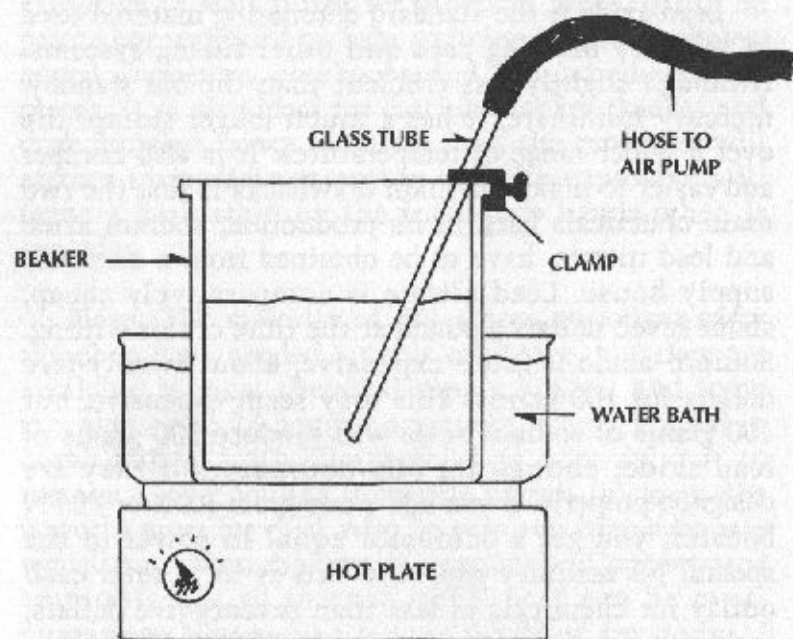

Solution A: Dissolve 2 grams of sodium azide and 60 milligrams of sodium hydroxide (lye) in 70 milliliters of distilled water.

Solution B: Dissolve 7 grams of lead nitrate and 400 milligrams of dextrin in 90 milliliters of distilled water. Adjust the pH of this solution to 5 by adding a diluted sodium hydroxide solution drop by drop—stirring after each drop.

Place solution B in a 300-milliliter beaker and heat in a water bath to 60 degrees C (140 F). Place the tube from an air pump into the beaker, as shown in the drawing, and regulate the air flow to produce a moderate agitation. Slowly add solution A, drop by drop, at a rate not to exceed 4 milliliters per minute.

When all of solution A has been added, turn off the heat, but continue the air flow until the liquid cools to room temperature. Pour the the solution through a filter to capture the lead azide on the filter. Wash the lead azide by pouring 4 portions of water (160 milliliters or the same amount as the liquid from which the crystals evaporated) through the filter. Air dry and the lead azide is ready to use. This formula yields about 4 grams or double the amount of sodium azide used.

RDX

RDX is used in most of the better explosives in service today, ranging from composition B, the standard bomb-filler used by the Air Force, to composition C-4, the best of the plastic explosives. The following process is the cheapest and easiest method I've found for RDX production. It uses only three chemicals—ammonium nitrate, acetic anhydride, and paraformaldehyde. All three are readily available, but procuring the acetic anhydride can be a bit touchy, however, as it is widely used in the production of the illegal drug methamphetamine, or "crystal," as it's called on the streets.

Fortunately, acetic anhydride is also used in many legal chemical processes, so authorities have found it impossible to restrict. It might be on the Drug Enforcement Agency's (DEA) watch list, at least informally, so buyers may choose to use a cover when purchasing it. I've never had any problems, but in some areas of the country, buying it could bring you unwanted attention. Knowing the legitimate uses for acetic anhydride could come in handy.

Paraformaldehyde is made by dehydrating common formaldehyde solution. Use caution because it is a known carcinogen. This method produces what is known as Type B RDX, which contains 8 to 12 percent HMX. Since HMX is slightly more powerful than RDX and has other useful explosive characteristics, no one gets too concerned about this "impurity." HMX is specifically mentioned in the government specifications for C-4.

Production

- 1) In a 4-liter boiling flask, pour 260 milliliters of acetic anhydride and 105 grams of ammonium

- nitrate (fertilizer grade is okay). Swirl the flask gently until most or all of the solids dissolve.
- 2) Place the flask in an oil or water bath on a hot plate. Heat to 70-90 degrees C (158-194 F).
- 3) Prepare a stopper to fit the flask, with a hose running to the outside.
- 4) Put on a dust mask and rubber gloves. Add 9.5 grams of paraformaldehyde and quickly replace the stopper. When the reaction has subsided, repeat 3 more times, until you have added a total of 38 grams. The resulting fumes are toxic and flammable, so good ventilation is a must.
- 5) Remove the flask from the bath and let it cool to room temperature. As it cools, the RDX crystals will precipitate from the solution. This is rather pretty, like one of those snowflake toys you played with as a kid.
- 6) *Carefully* pour this solution into a container with at least 1 gallon of water, preferably more. (The liquid holding the RDX is now glacial acetic acid, an extremely strong caustic. When diluted, it becomes what is basically impure vinegar and may be safely disposed of down the drain.)
- 7) Make a paper funnel to filter the white crystals out of the liquid. Wash the crystals that remain on the filter with 2 portions of cold water, then 2 portions of hot water. Allow to dry.
- 8) Heat a pan of water to boiling, remove it from the heat source, and place an open container of acetone into the pan until the acetone itself almost boils. (Because acetone and its vapors are flammable, the water should be brought to a boil on a stove, then moved away from the heat source *before* placing the acetone container in it.) Add the hot acetone to the crystals, using just enough to dissolve them. When cool, the RDX will precipitate out of the acetone. Chill the liquid in

the refrigerator for a couple of hours, then filter to remove the RDX. Spread the crystals on a nonporous surface so the excess acetone can evaporate. It is now ready for use.

RDX PRODUCTION SETUP

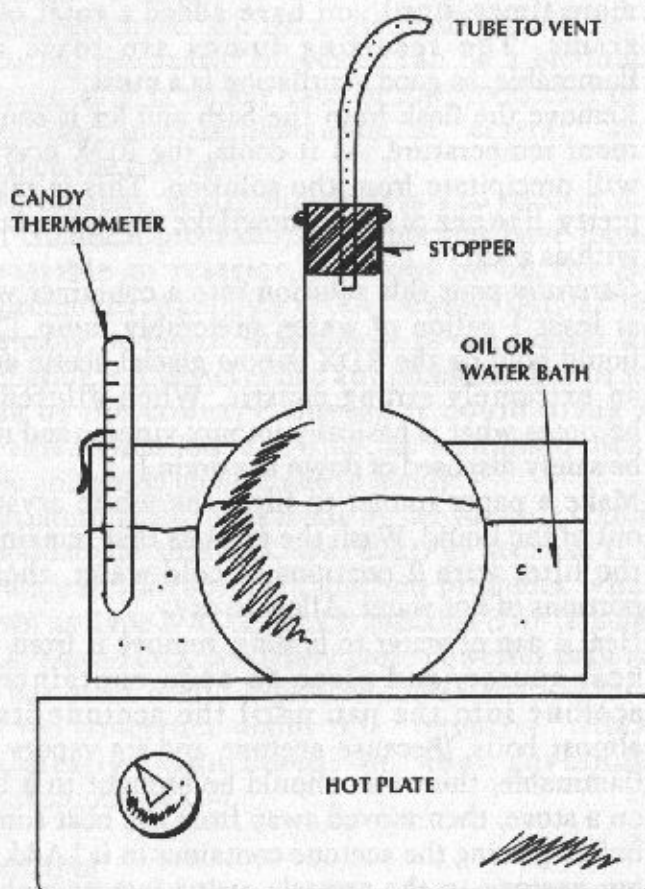

LEWIS BOMB

The Lewis bomb was developed in late 1941 by Lieutenant Jock Lewis, one of the early members of Britain's elite Special Air Services (SAS) unit. The need for such an explosive arose because SAS airfield raids were succeeding in blowing up the fuel tanks of German aircraft but failing to ignite the petrol in them. These raids were difficult and risky, and the SAS troops were satisfied with nothing less than total destruction of the aircraft.

They first referred the problem to the Royal Engineers, who came up with a large, bulky device weighing five pounds and requiring ten minutes to set up. David Sterling, head of SAS, considered this device too bulky and slow for SAS use and assigned Lt. Lewis the task of coming up with a more effective solution. Lewis believed that a mixture of the recently developed plastic explosive and thermite powder would do the trick, but after two weeks of experimentation, he was unable to get the proper mix. While working on the firing range one day, he spotted a large can of rifle oil and tried including it in the mix. The results were spectacular. He had a bomb that weighed about one pound and would explode fuel tanks and ignite the petrol. Named after its creator, the Lewis bomb became standard issue for SAS airfield raids and has proven its worth many times.

For use against aircraft, the one-pound size is still best because it has to blow through the structural members of the wings or fuselage to get to the fuel. For standard motor vehicles, a bomb of four ounces or less will suffice. In fact, the gas-tank mine used by CIA back when they used to do that sort of thing contained slightly more than an ounce of a similar mix.

A device made from a common disc-shaped snuff

can is just the thing for automobiles. Place a square of padded, double-sided adhesive tape on one side to attach it to the fuel tank, add a delay fuze, and it's ready. For large trucks, a device made from a six and one-half ounce tuna fish can works well. If you attach a Lewis bomb to the gas tank of every second car in a motor pool or car park, you are assured a merry blaze.

Lewis mix can be made from three parts plastic explosive, one part oil, and two parts thermite, aluminum, or magnesium powders. Add the oil to the plastic and blend to a smooth, sticky paste. Add the metal powder to the paste and knead until a uniform mixture is obtained.

Note: Current military aircraft generally come equipped with explosion-resistant fuel tanks. However, considering the way they go up when they crash at air shows, this may not be much of a deterrent. It is something to be considered, however.

FUEL-AIR EXPLOSIVES

It has long been known that hydrocarbon vapors or fine dusts dispersed in a cloud are violently explosive when ignited. The many coal-mine disasters from exploding methane pockets or explosions from grain dust bear witness to this. Toward the end of the Vietnam War, the U.S. military began experimenting with fuel-air explosives (FAE). The basic technique involves rupturing the fuel tank, allowing a fuel cloud to spread until the optimum fuel/air mixture is reached, and then detonating the cloud. Military explosives experts tested various fuels, ranging from exotic (ethylene oxide, propylene oxide) to common (propane, butane, MAPP gas). Properly detonated, FAE produces a blast four times as powerful as an equal weight of TNT. The pressure pulse of the explosion is also longer than that of TNT so it causes more damage.

The gas-enhanced bombs described here are even more destructive. Terrorists used bombs of this type in their attacks on the U.S. embassy and the marine barracks in Beirut in 1983. Explosives experts initially attributed the marine bombing to about 12,000 pounds of TNT, judging from the tremendous damage caused by the explosion. Israeli intelligence experts now believe the bombs were composed of about 600 pounds of an RDX-based explosive and a propane booster. They also believe that the bombs were prepared by East German advisors working with Syrian terrorists because production of FAE is relatively specialized and not widely known.

The explosive power of FAE amazes even explosive ordnance disposal (EOD) personnel. Experts have estimated that a liquefied natural gas (LNG) tanker, if detonated, would produce the blast equivalent of a nuclear weapon. A propane truck, properly fuzed and

FAB DETONATION SEQUENCE

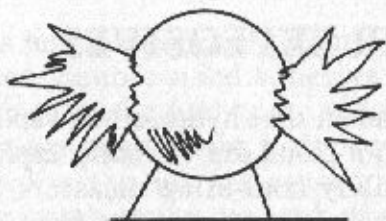

1. TANK RUPTURES.



2. GAS HITS THE AIR AND BEGINS TO FORM A CLOUD.

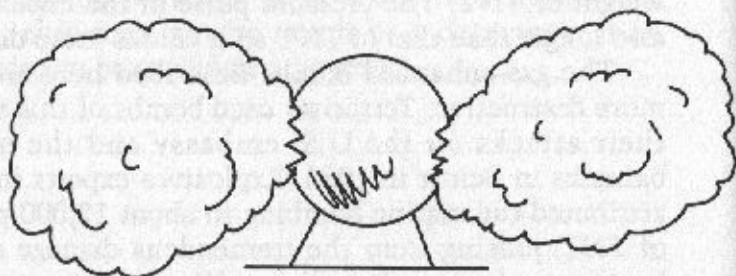

3. GAS EXPANSION CONTINUES UNTIL CLOUD REACHES OPTIMUM DENSITY.

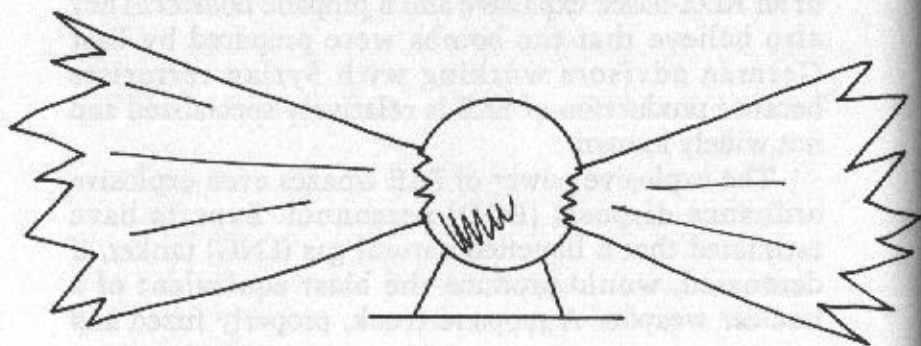

4. DETONATION.

placed in a vulnerable spot, is awesome to behold when detonated. Some potential target installations already have their own propane tanks, so all you have to do is fuze them. At 60 degrees F, one gallon of liquefied propane yields 36 cubic feet of pure gas. Since the explosive fuel/air ratio for propane is 2 to 10 percent of fuel to air, the 5-gallon cloud should cover about 2,000 cubic feet in volume when the main charge detonates. The other two sizes will be proportionally larger.

The sequence of detonation is as follows. An electric pulse from the timer detonates the bursting charges, which in turn rupture the tank. When the propane hits the air, it expands violently to form a cloud of fuel and air. After a brief delay (usually about 125 milliseconds), the main charge explodes, detonating the cloud. The delay may be set by using an electronic delay circuit, but it is far easier to use a commercial delay blasting cap such as the Du Pont number 5. Larger FAE charges may need a longer delay than 125 milliseconds.

Directions follow for bombs using the three most common refillable propane tanks: 5-gallon jug, 24-gallon cylinder, and 50-gallon sphere. All operate alike but use different bursting techniques.

5-Gallon FAE

This bomb uses the smallest refillable propane bottle commercially available. The 5-gallon size is the common, squat, round bottle used for trailers and barbecue grills and holds a little more than 20 pounds of liquefied propane when full. A 10-pound high-explosive main charge detonates this bomb. To prepare:

- 1) Wrap 5 turns of detonating cord around the propane bottle, on the centerline. Cover this with several layers of tightly wrapped duct tape. Leave a 12-inch tail of det cord exposed on one end.
- 2) Place the bottle on a box containing the main

FIVE-GALLON FAE

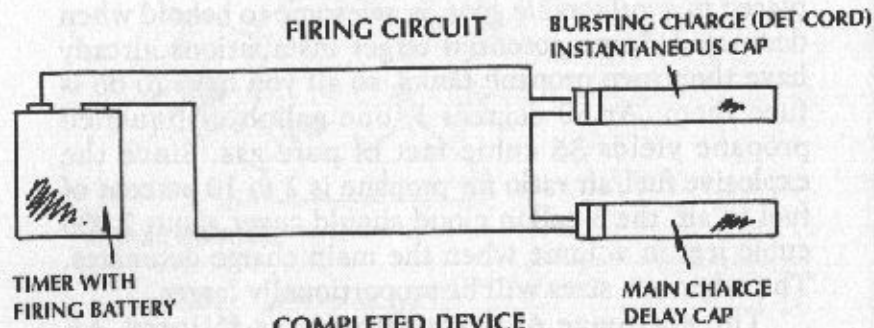

COMPLETED DEVICE

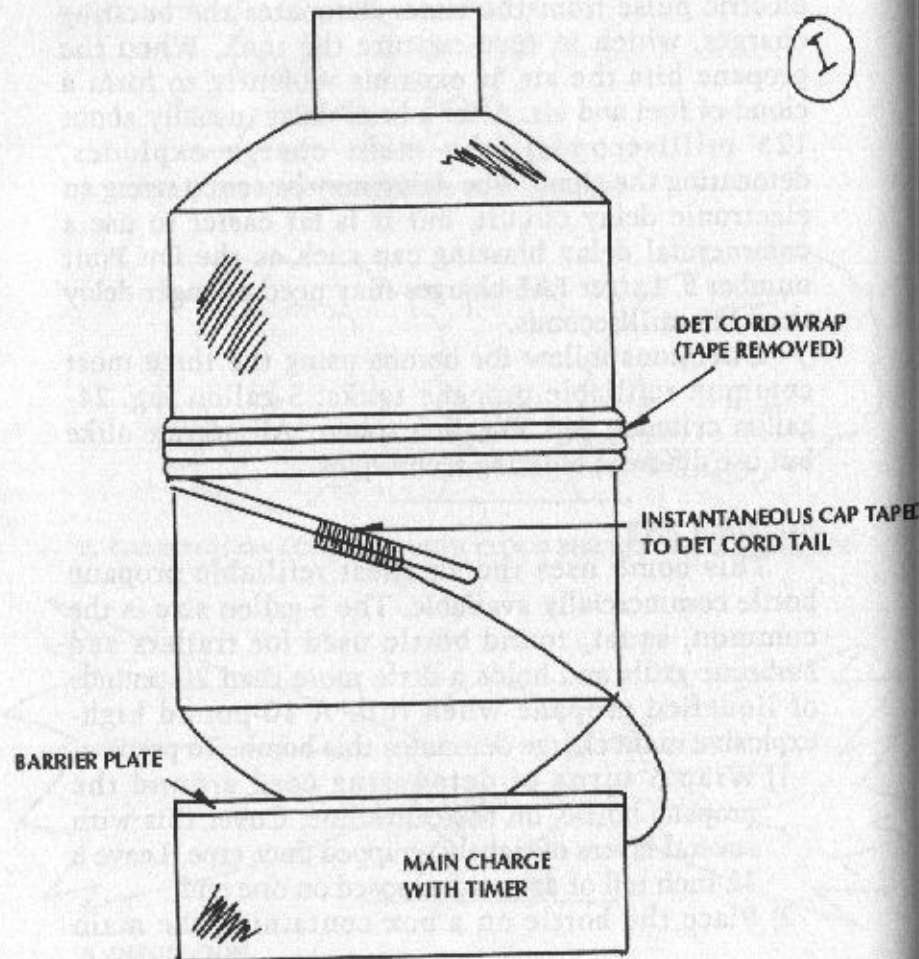

charge and firing circuit. Insert a 1/16-inch steel barrier plate between the tank and main charge to protect the main charge and the firing circuit from the explosion of the det cord and subsequent expansion of the gas cloud. If you prefer, house the main charge and timing circuit in a 50-caliber ammo can, which eliminates the need for a barrier plate.

- 3) This device uses 2 different types of detonators: a regular instantaneous electric blasting cap and a 125-delay cap. The regular cap is connected to the det cord strand, while the delay cap is placed in the main charge. They are wired in series to the timer (see circuit drawing).

When the timer energizes the blasting caps, the det cord fires, opening the tank. The propane spreads out in a roughly doughnut shaped cloud for 125 milliseconds when the main charge fires.

One person can easily carry and emplace this charge. This is easier if it is mounted on a packboard.

24-Gallon FAE

A 24-gallon propane cylinder measures 18 inches in diameter by 42 inches long. It weighs 100 pounds empty and approximately 200 pounds full. To make into an FAE, run a 36-inch-long by 1-inch-wide strip of sheet explosive (Detasheet or M-118) lengthwise down each side of the propane tank (see illustration at left). This burster weighs about 1/2 pound for each side. Place a 50-pound main charge and firing circuit in an 1/8-inch shielded box underneath the tank. Wire as shown in the diagram. This can be carried in a truck.

50-Gallon FAE

The 50-gallon propane tank is a 3-foot diameter

TWENTY-FOUR-GALLON FAE FIRING CIRCUIT

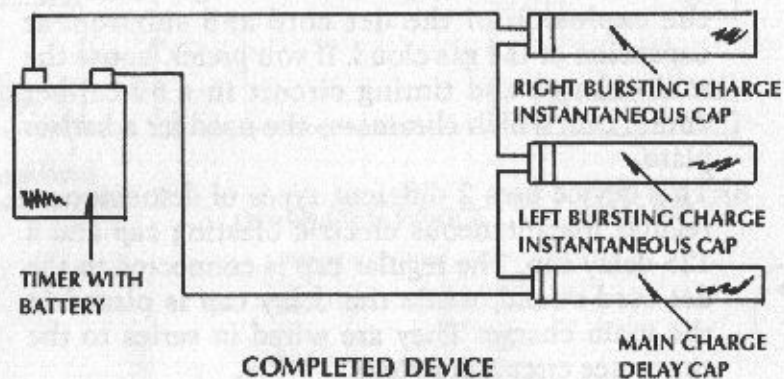

COMPLETED DEVICE

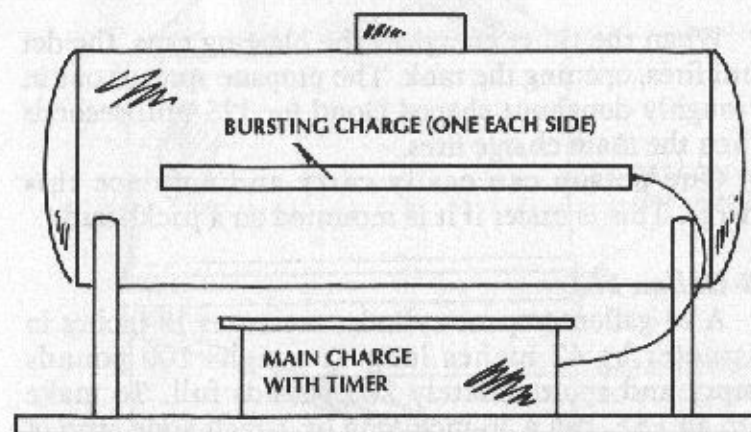

sphere with supporting legs. It weighs about 200 pounds empty and 400 pounds full. The burster has two 1-inch-wide rings placed horizontally around the top and bottom of the tank; 4 vertical strips run every 90 degrees, connecting the rings. As with the other 2 FAEs, the main charge and timer rest in a well-shielded box at the base. Because of the size and power of the bursting charge, the barrier should be at least 1/4-inch steel. One (instantaneous) detonator will set off the

FIFTY-GALLON FAE FIRING CIRCUIT

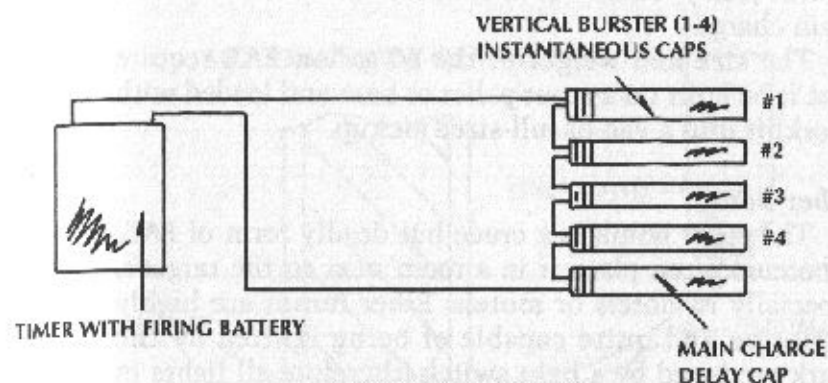

COMPLETED DEVICE

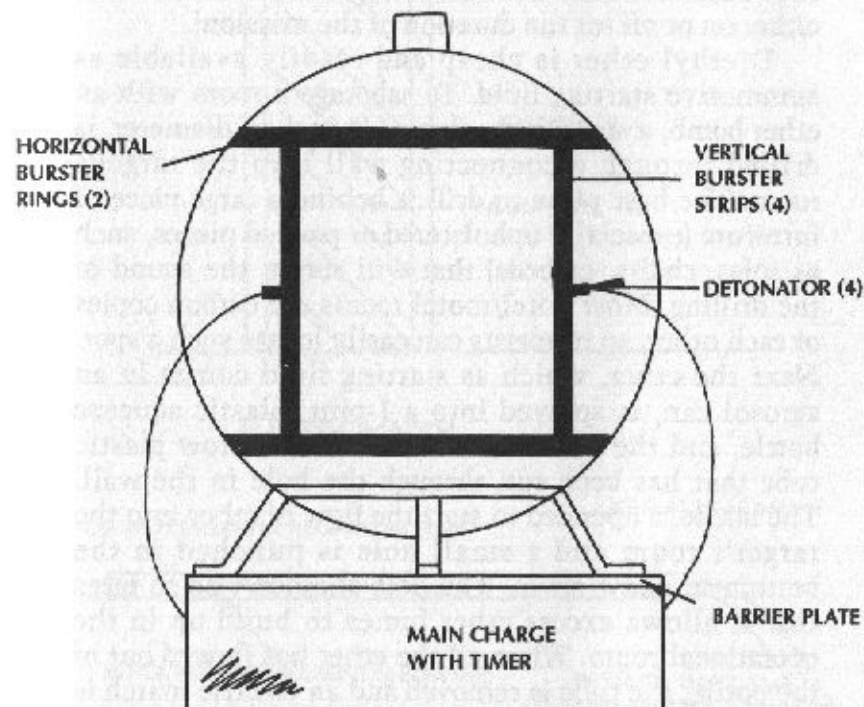

explosive, but 4 will guarantee maximum performance from the burster charge. The detonators are connected to the centers of the 4 vertical strips of sheet explosive. A fifth (delay) detonator is connected to the 100-pound main charge.

The size and weight of the 50-gallon FAE require that it be built on a stout pallet or base and loaded with a forklift into a van or full-sized pickup.

Ether Bomb

The ether bomb is a crude but deadly form of FAE. Saboteurs often place it in a room next to the target's, especially in hotels or motels. Ether fumes are highly explosive and quite capable of being ignited by the spark produced by a light switch (therefore all lights in the room in which the bomb is placed should be left either on or off for the duration of the mission).

Diethyl ether is cheap and readily available as automotive starting fluid. To sabotage a room with an ether bomb, a small hole, about 1/4-inch in diameter, is drilled through a connecting wall into the target's room. The best place to drill is behind a large piece of furniture (especially upholstered or padded pieces, such as sofas, chairs, or beds) that will soften the sound of the drilling. Most hotel/motel rooms are carbon copies of each other, so terrorists can easily locate such a spot. Next the ether, which as starting fluid comes in an aerosol can, is sprayed into a 1-pint, plastic squeeze bottle, and the bottle is attached to a narrow plastic tube that has been run through the hole in the wall. The bottle is upended to start the flow of ether into the target's room and a small hole is punched in the bottom to allow air in. The hole shouldn't be so large that it allows excess ether fumes to build up in the operational room. When all the ether has flowed out of the bottle, the tube is removed and an electric match is inserted through the hole. This is attached to a short

ETHER BOMB

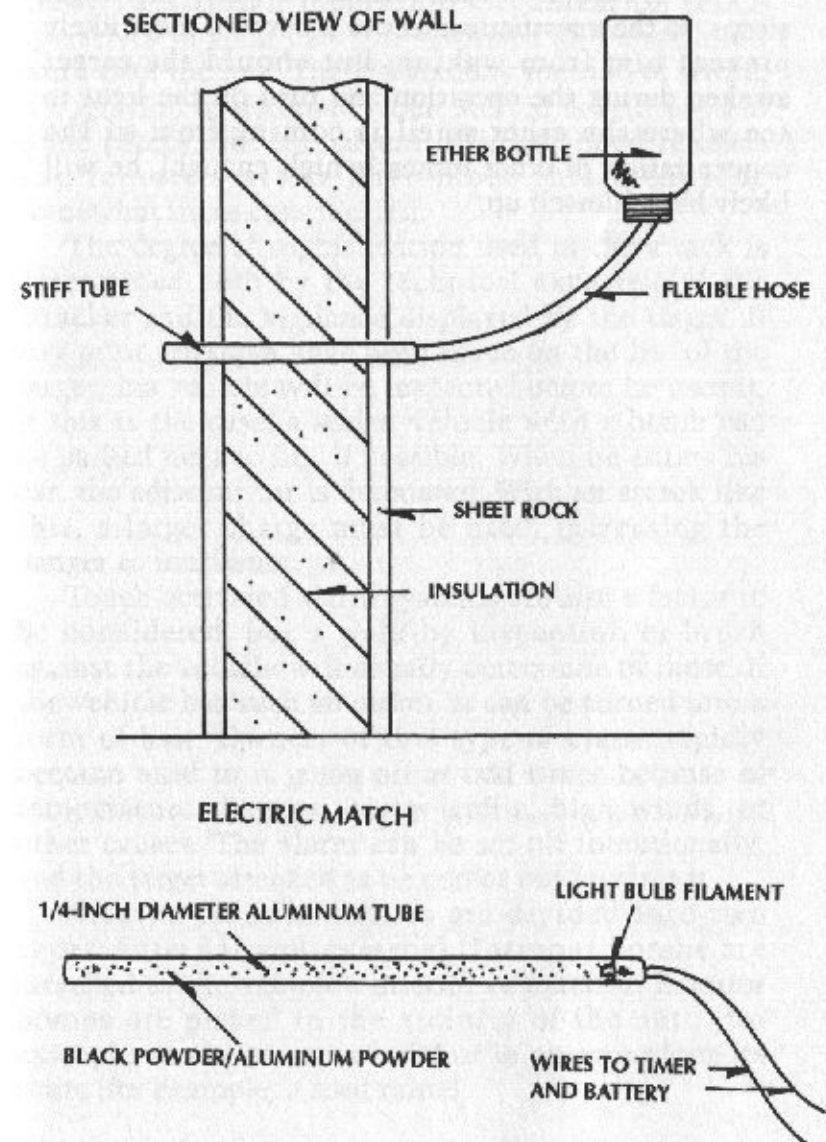

delay timer, and the operational room is vacated. When the timer completes its run, the circuit closes and the match shoots a spurt of flame into the target room, igniting the ether fumes.

This operation is best conducted while the target sleeps, so the anesthetic effect of ether will most likely prevent him from waking. But should the target awaken during the operation and turn on the light to see where the ether smell is coming from (if the concentration of ether fumes is high enough), he will likely blow himself up.

AUTOMOBILE BOMBS

The automobile has been a favorite assassination tool since the 1920s. The Israelis have blown up so many Palestinian Liberation Organization (PLO) operatives in their cars I'm surprised all Palestinians don't take the bus. The old standby method of wiring the ignition to detonate when started is still used in some places, but the advent of inside hood releases and remote starters have made this technique somewhat more complicated.

The degree of sophistication used in the attack is determined both by the technical expertise of the attacker and the vigilance displayed by the target. If any prior attempts have been made on the life of the target, his vehicle will be inspected before he uses it. If this is the case, a stolen vehicle with a bomb can be parked next to his, if possible. When he enters his car, the adjacent car is detonated. With an attack like this, a larger charge must be used, increasing the danger to innocents.

Touch-activated alarm systems are also a factor to be considered, but a walk-by inspection or brush against the vehicle will usually detect one of these. If the vehicle has such an alarm, it can be turned into a form of bait. Owners of this type of alarm rapidly become used to it going off at odd times because of temperature changes, heavy traffic, high winds, or other causes. The alarm can be set off intentionally, and the target attacked as he comes out to reset it.

Attacks on automobiles are divided into two types: internal and external. Internal bombs are attached to the vehicle's interior or exterior. Exterior bombs are placed in the vicinity of the auto (for example, in the car next to it) or in an area along its route (for example, a road mine).

Internal Automobile Bombs

Electrically detonated devices may be wired to any switch in the car, they detonate upon turning on the lights, stepping on the brake, releasing the emergency brakes, or some other action. However, this requires an intimate knowledge of the circuitry of the particular vehicle. Below are six types of internal automobile bombs.

Coil Ignition Auto Bomb

Wiring the explosive charge to the coil to detonate when the automobile is started is probably the oldest car-bombing technique. One wire from the detonator is clamped to the input (+) side of the coil, while the

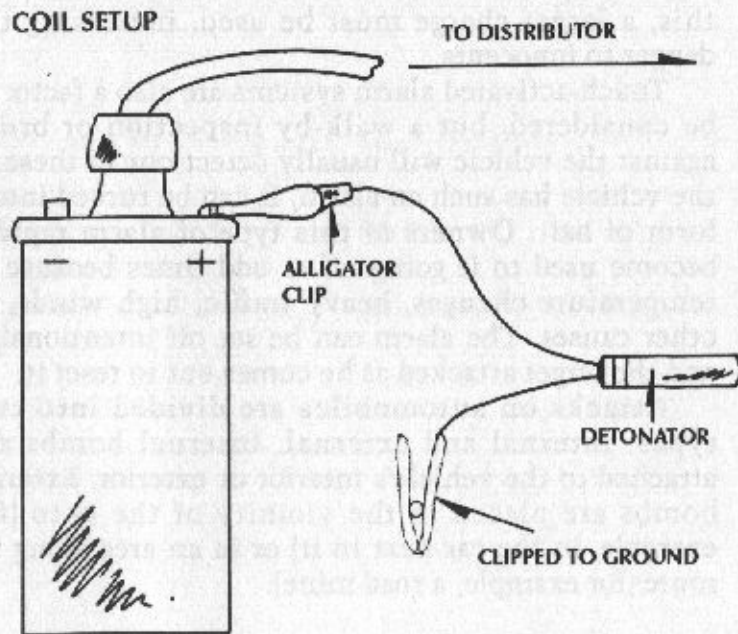
IGNITION INSTALLATION

other wire is clamped to the frame as a ground. The explosive charge itself can be laid on the engine or, even better, fastened to the firewall in front of the driver's position. A charge of 3/4-pound of plastic explosive or 3 sticks of dynamite is typical, but 1/2-pound would be ample if shrapnel is added. With practice, it takes less than 30 seconds to emplace this device, but locked hoods greatly increase the time required for installation.

Starter Solenoid Auto Bomb

The starter solenoid has three terminals, one large and two small. The large one runs directly to the battery and should be avoided. An electric detonator equipped with shrouded (insulated) alligator clips is clamped to the two smaller terminals. The explosive charge itself may be attached with magnets to the underside of the car or taped to the frame. The advantage is that it requires no internal access to the

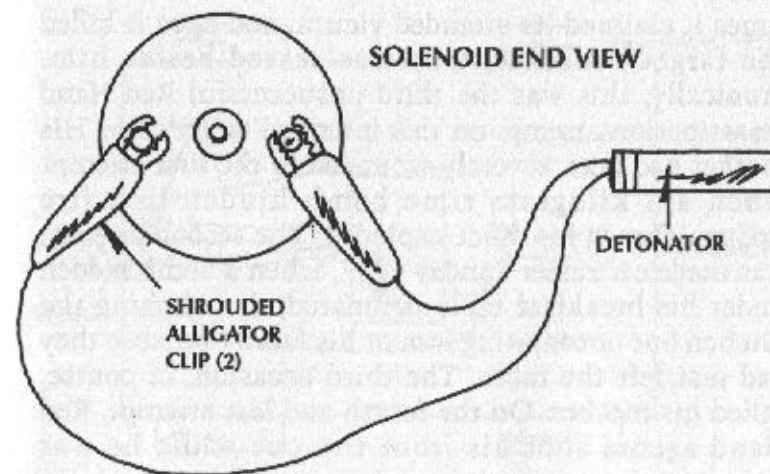
SOLENOID SETUP

vehicle. The disadvantage is that the underside clearance may be too low to crawl under. These techniques are useful only against low-level agents or informers. It is unlikely that a seasoned professional or security officers for a high-ranking official would be trapped by it.

Magnetic Auto Bomb

This bomb was first used by a French paramilitary organization known as the Red Hand, which operated from 1956 until Algerian independence in 1962. Their main job was to discourage Western arms dealers from providing the Algerian rebels with war materiel. Primarily, the Red Hand employed bribery and intimidation to achieve its goal. Their agents offered arms dealers the same amount of money to renege on a sale as they would have made from the Algerians. The offer had a double appeal: the arms dealers did not suffer any financial loss, and as an added bonus, they would be allowed to live a while longer. Most arms dealers cooperated with the French or found safer lines of work. Those who didn't were generally killed.

The magnetic auto bomb is known to have been used in at least four murders by the Red Hand. Three times it claimed its intended victim, and once it killed the target's mother, who was seated beside him. (Ironically, this was the third unsuccessful Red Hand assassination attempt on this intended target's life. His mother had been severely wounded in the first attempt when a 5-kilogram time bomb hidden in a fire extinguisher in his office exploded. The second attempt was made on Easter Sunday 1957, when a bomb hidden under his breakfast table detonated, demolishing the kitchen but not injuring him or his family because they had just left the table. The third occasion, of course, killed his mother. On the fourth and last attempt, Red Hand agents shot his front tire out while he was

MAGNETIC AUTO BOMB

SIDE VIEW (SECTIONED)

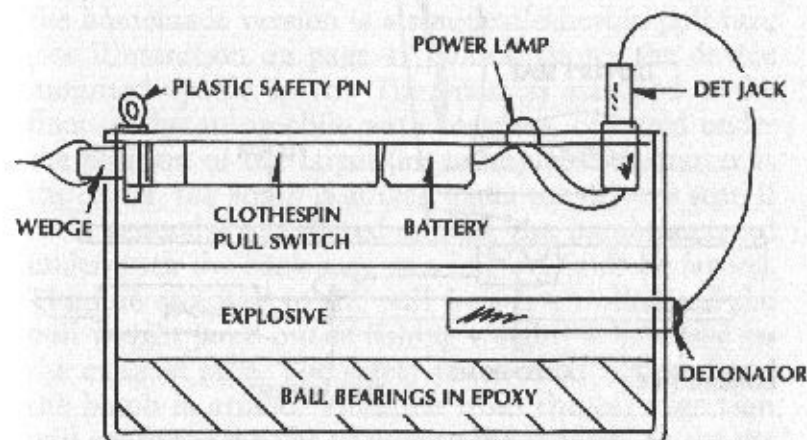

TOP VIEW (COVER REMOVED)

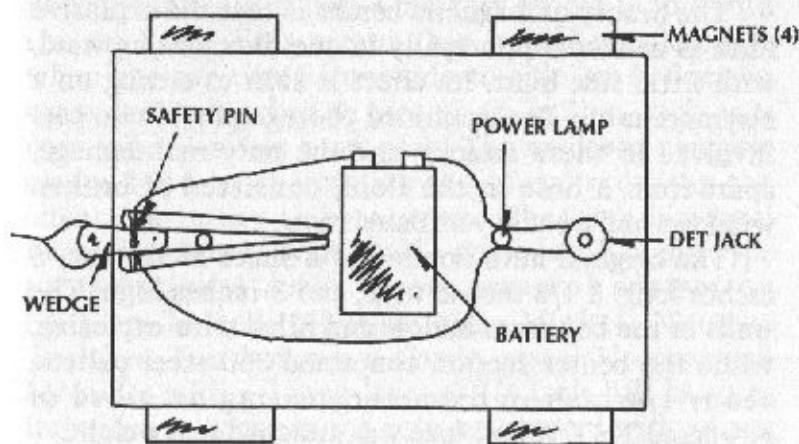

MAGNETIC AUTO BOMB INSTALLATION (EXAGGERATED FOR CLARITY)

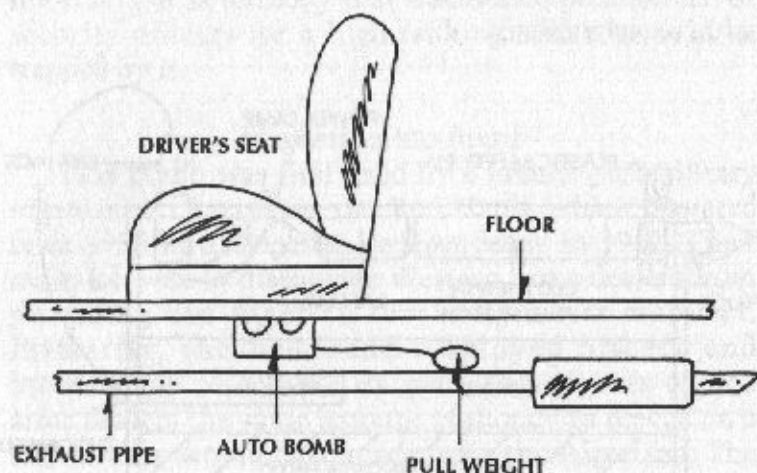

travelling at seventy miles an hour on the autobahn. The car left the road, somersaulted, and landed on its roof. He walked away without a scratch. Allegedly, the head of French covert operations forbade any further attempts on his life.)

The beauty of magnetic bombs is that the explosive force is delivered principally in one direction, upward, with little side blast. Its effect is akin to sitting on a claymore mine. I've examined photographs of two cars involved in these attacks, and the only real damage, apart from a hole in the floor, consisted of broken windows and a badly ventilated roof.

The original auto bomb was a sheet metal box, 5 inches long, 3 1/2 inches wide, and 3 inches high. The walls of the box were hollow and filled with explosive, while the center section contained 350 steel pellets, about 1/4-inch in diameter, resting on a bed of powdered TNT. A pull fuze was attached to a weight.

The exact size of the device varies depending on the materials on hand. If steel pellets are unavailable, then small nuts and bolts might be used. The Irish Republican Army (IRA) refers to these as "shipyard confetti." Lead buckshot is ineffective because it loses too much power piercing the floorboards. The fuze in the homemade version is a simple clothespin pull fuze (see illustration on page 47, which shows the device mounted upside down). The bomb is attached to the floor of the automobile with magnets, centered under the position of the target (for example, if the target is the driver, the bomb is affixed under the driver's seat; if he is generally chauffeured around, the bomb is placed underneath the back seat on whichever side he favors). The line attached to the pull fuze is unrolled and the pull weight (an 8-ounce fishing weight) is balanced on the exhaust pipe. The safety pin is then removed and the bomb is armed. Vibration from the car's ignition will cause the weight to drop to the ground. As the car pulls forward, the weight pulls the wedge from the clothespin, and the bomb detonates.

Tilt-Fuzed Auto Bomb

This device is ideal for targets who park in underground lots. It uses a mercury switch in line with the car body. This means that it will not detonate when the car turns from side to side, as it does on entry, but only when it goes up an incline, such as it does when leaving a car park. The enclosed concrete ramps tend to channelize the blast, reducing the chance of injury to bystanders. The Irish National Liberation Army (INLA) used a crude bomb of this type to assassinate Airey Neave, special advisor on Northern Ireland to British Prime Minister Margaret Thatcher. The casing is a plastic, resealable sandwich container with a 1-inch layer of 1/4-inch ball bearings imbedded in epoxy in the bottom, covered with a layer

TILT AUTO BOMB

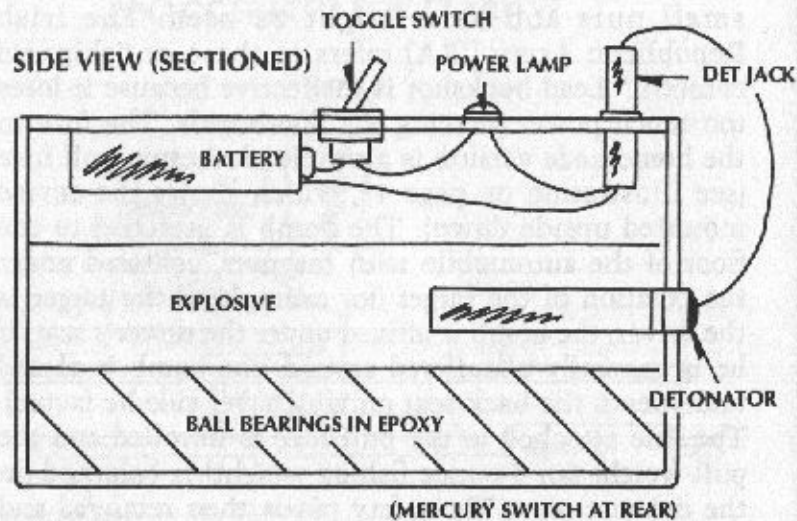

BOTTOM VIEW

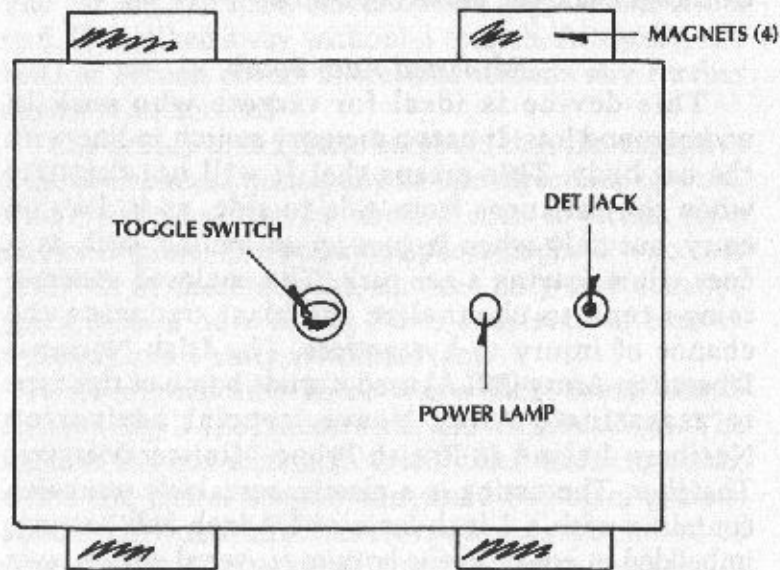

TILT AUTO BOMB

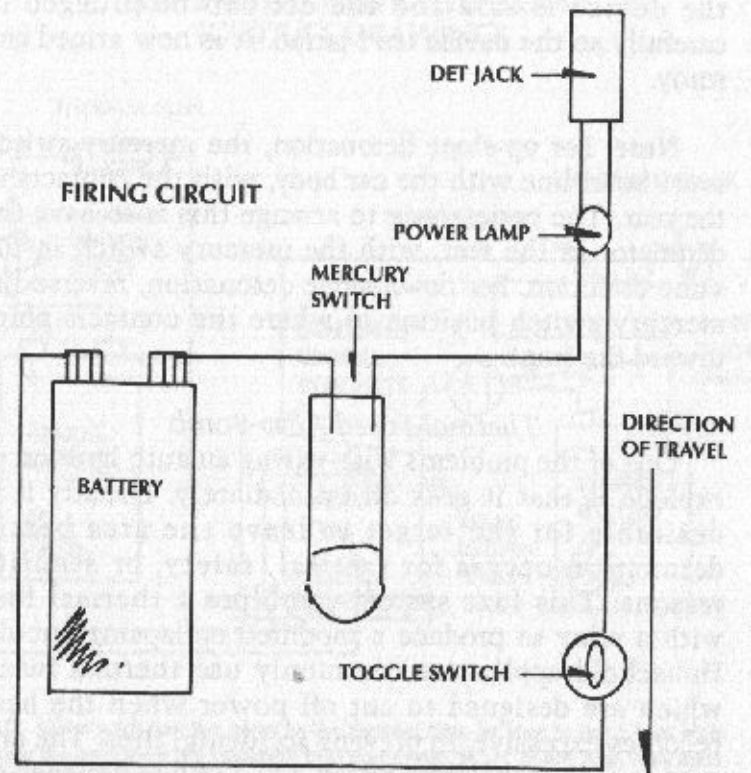

of plastic explosive weighing about 3/4 of a pound. The leg wires of the detonator are soldered to a 3/32-inch headphone plug. This is inserted into an appropriately-sized jack built into the container lid, once the circuit has been determined safe (see illustrations on page 50). The circuit is not complicated.

The tilt-fuzed bomb is placed under the floor of the car, approximately 12 inches in from the door and 6 to 8 inches forward of the door jamb. After the det is unplugged, the toggle switch is flipped on. If the red light comes on, it means there is power to the det jack. If the detonator were plugged in at this point, the bomb

would explode. If the red light does not come on, then the device is safe and the det can be plugged in carefully so the device isn't jarred. It is now armed and ready.

Note: For up-slope detonation, the mercury switch must be in line with the car body, with the contacts to the rear. The easiest way to arrange this is to have the detonator in the rear, with the mercury switch in the same direction. For down-slope detonation, reverse the mercury switch position to where the contacts point toward the front.

Thermal-Fused Auto Bomb

One of the problems with wiring an auto ignition to explode is that it goes off immediately. Usually it is desirable for the target to leave the area before detonation occurs for tactical, safety, or security reasons. This fuze system combines a thermal fuse with a relay to produce a modified collapsing circuit. Household appliances commonly use thermal fuses, which are designed to cut off power when the heat becomes excessive, to prevent accidental fires. The one used in this case (Radio Shack 270-1320) is designed to break power at 141 degrees C (286 degrees F). The fuse is attached to the manifold, exhaust pipe, muffler, or catalytic converter with a small square of duct tape. The fuse is attached to the main charge by long wires. When the object reaches 141 degrees C, the fuse will fail, cutting power to the relay and closing the firing contacts. The amount of time required for this varies with the type of vehicle and location of the fuse. This bomb is not limited to cars. Any object that becomes hotter than the fuse temperature is suitable. The charge illustrated is the standard controlled-fragmentation auto bomb assembly.

1) The auto bomb is attached to the vehicle floor

THERMAL-FUSED AUTO BOMB (CIRCUIT DRAWING)

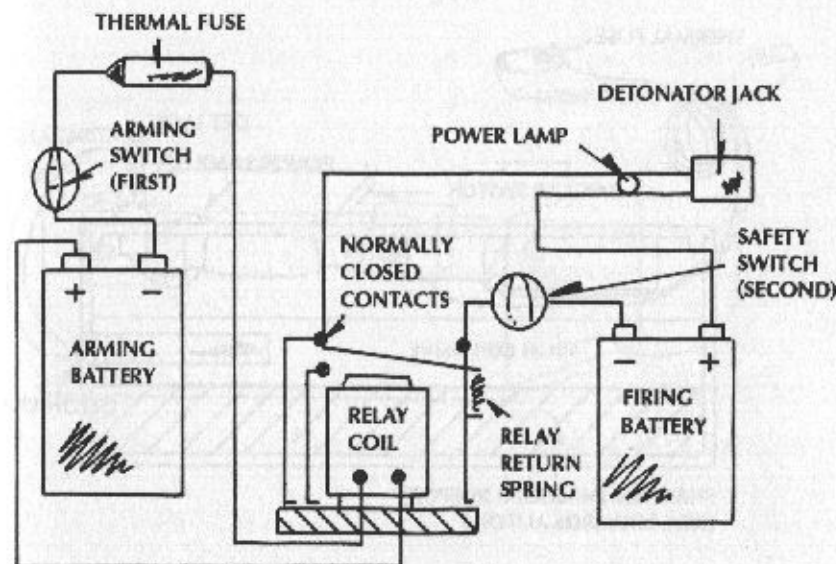

NOTE: When soldering the wires to the thermal fuse, be sure to use a heat sink because the heat from the soldering iron may cause failure of the fuse. Also note that the thermal fuse has two ends: power in and power out. Be sure that these are wired properly. Refer to the package to find out which is which.

- with magnets and checked for accurate placement.
- 2) The wires are unreeled and the fuse taped to desired object.
- 3) The left toggle switch (relay battery) is flipped to on, then the right toggle switch (firing battery) to on. If the red light comes on, it indicates there is power to the detonator jack. Turn off both switches and try again. Make sure they are switched in the right order, left then right. If the light comes on again, the device is defective and

**THERMAL-FUSED AUTO BOMB
(SECTIONED SIDE VIEW)**

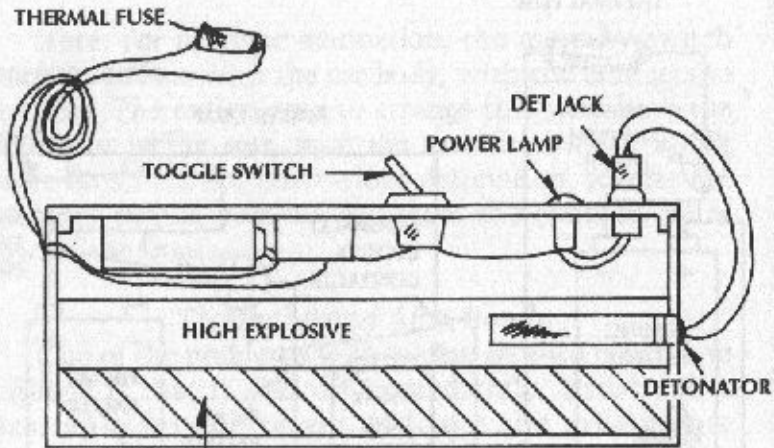

SHRAPNEL IMBEDDED IN EPOXY
(SIDE TOWARDS AUTO)

TOP VIEW

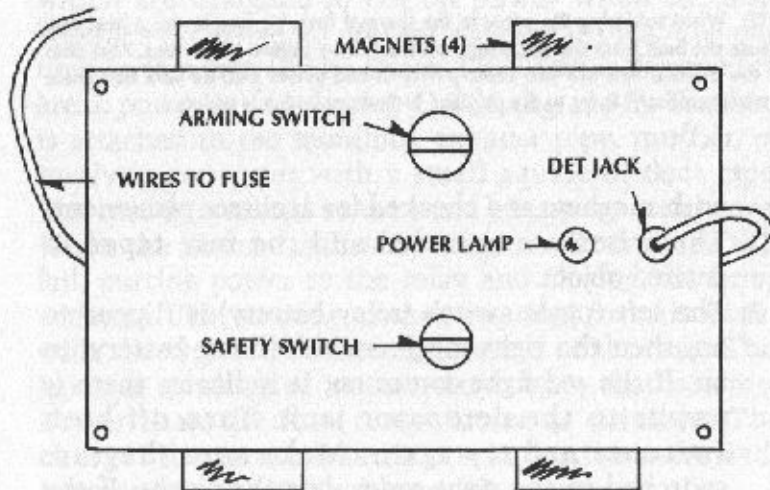

THERMAL-FUSED AUTO BOMB

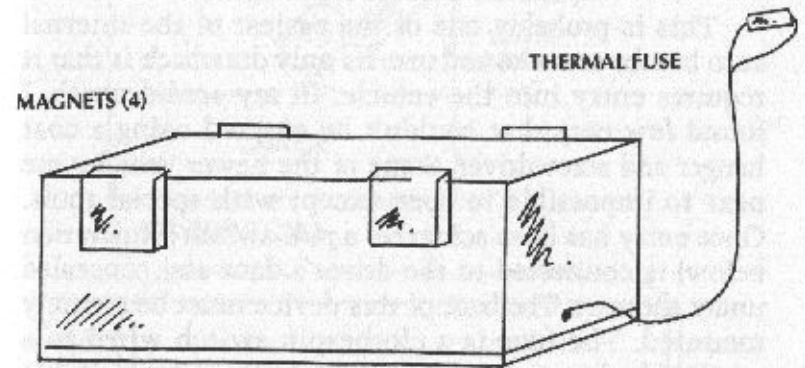

UNDERSIDE OF CAR
(EXAGGERATED FOR CLARITY)

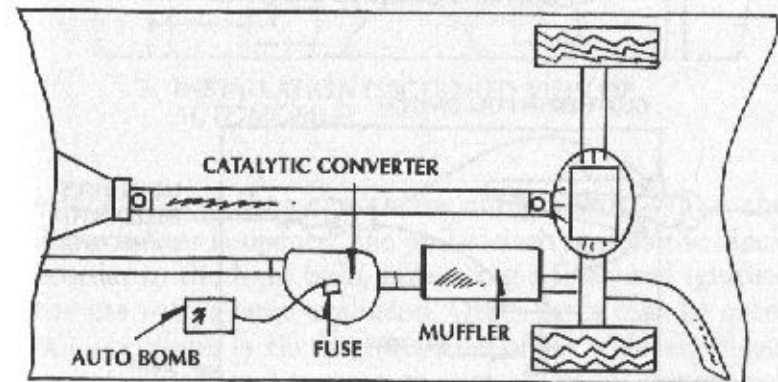

should not be used.

- 4) If the light does *not* come on, the detonator can be plugged in. The device is armed and ready.

Calcium Carbide Auto Bomb

This is probably one of the easiest of the internal auto bombs to make and use. Its only drawback is that it requires entry into the vehicle. In my sordid youth, I found few cars that couldn't be entered using a coat hanger and screwdriver. Some of the newer vehicles are next to impossible to open except with special tools. Once entry has been achieved, a pull-switch (illustration below) is connected to the driver's door and concealed under the seat. The base of this device must be securely mounted. The fuze is a clothespin switch wired to a small, black-powder-filled light bulb and a suitable battery. When everything is in place, a can containing a half-pound of carbide is concealed under the seat and a pint of water quickly added. The passenger door is closed. The water hitting the carbide generates acetylene gas, which quickly fills the car's interior. In

CALCIUM CARBIDE BOMB

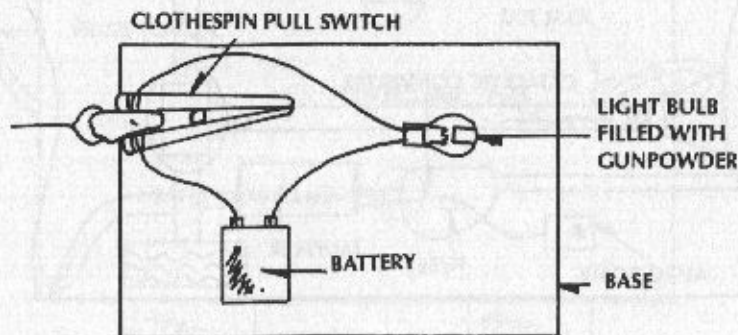

1. FIRING DEVICE

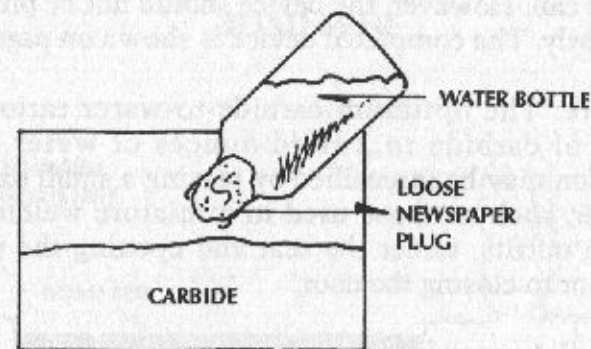

2. CARBIDE CAN

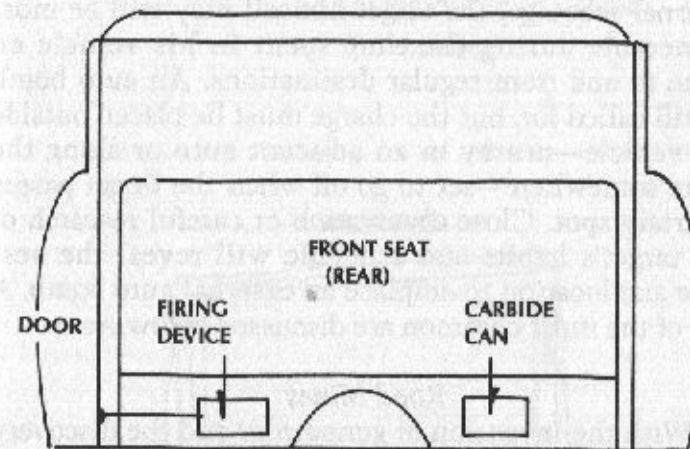

3. INSTALLATION (SECTIONED VIEW OF AUTOMOBILE)

effect, this makes the entire car a bomb. When the driver's door is opened, the pull-switch ignites the black powder in the light bulb, generating a flash and igniting the gas with a large explosion. Other gases may be used, but acetylene is the best because of its wide air-to-gas ratio (as little as 2 percent or as much as 80 percent gas in the air). If an arming delay is desired, use a water-filled bottle, loosely plugged with newspaper, in the

carbide can. However, the device should not be plugged too tightly. The completed device is shown on page 59.

Note: The optimum carbide-to-water ratio is 1 ounce of carbide to 2 fluid ounces of water. The explosion may be intensified by placing a small oxygen canister, such as those used in miniature welding or brazing outfits, under the seat and opening the valve just prior to closing the door.

External Automobile Bombs

Even if the target's automobile is not susceptible to internal sabotage, the target himself may still be most vulnerable during the time spent in his vehicle en route to and from regular destinations. An auto bomb is still called for, but the charge must be placed outside the vehicle—nearby in an adjacent auto or along the route somewhere—set to go off when the target passes a certain spot. Close observation or careful research of the target's habits and schedule will reveal the best time and location to emplace an external auto bomb. A few of the most common are discussed below.

Road Mines

With the invention of gunpowder and the discovery of its explosive properties, it became great sport to dig tunnels under an area where an enemy resided or rested and blow him up. In the static warfare of World War I, both sides would attempt to tunnel under the enemy's trenches and detonate large quantities of explosives. On one morning in 1917, British forces simultaneously set off 19 separate charges, totaling slightly over one million pounds of explosive. Today we use a bit less. The main targets are motor vehicles, though the same principles would apply to tunneling under a structure.

Using the cover of a road-repair crew, terrorists often place charges directly under the road surface.

ROAD MINE

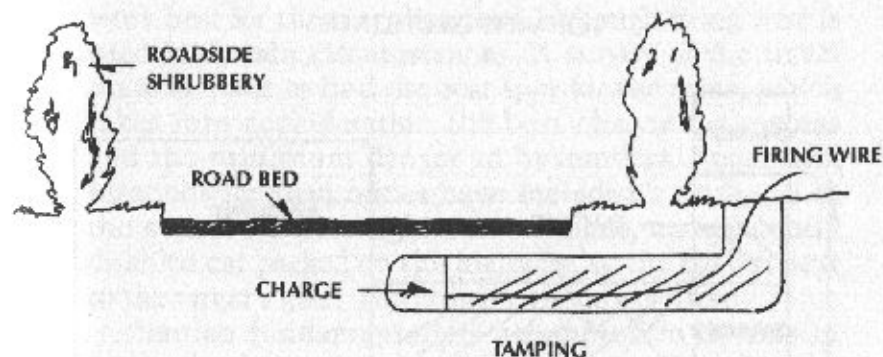

SHORING

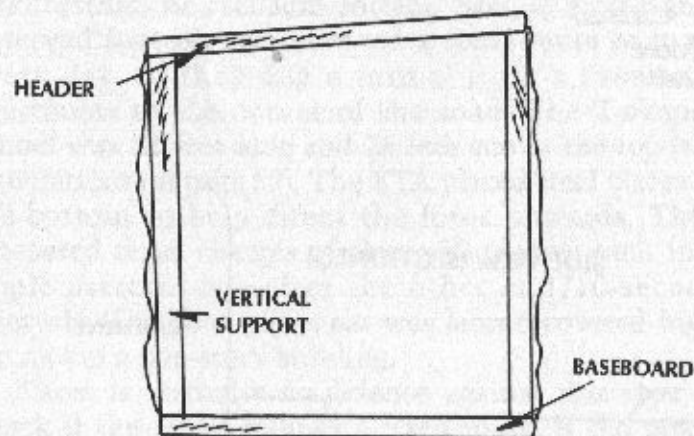

Place baseboard first, then header. Hammer in vertical supports so that they are wedged in tightly.

ROAD MINE USED IN BLANCO ASSASSINATION (NOT TO SCALE)

TOP VIEW (SECTIONED)

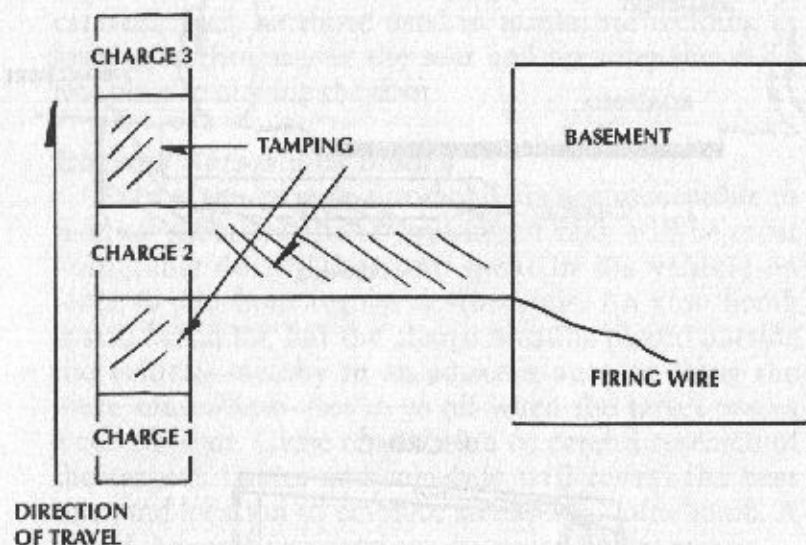

SIDE VIEW (SECTIONED)

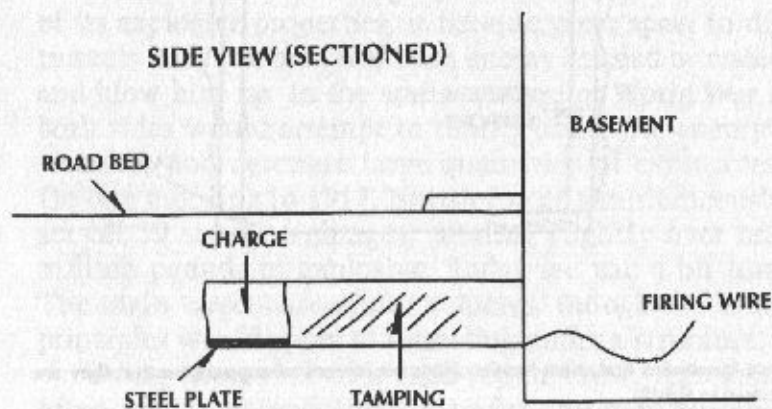

About 50 pounds of TNT is sufficient for most vehicles.

Mines may also be hidden in roadside shrubbery, parked cars, trash cans, or mail boxes. Radio-fired fuzes work best for these applications, although firing wire is used in certain circumstances. A survey of the travel route is made to find the best spot for the mine, which takes into consideration the best chance for success and the minimum danger to bystanders. Successful locations for road mines have included a trash can at the corner where a right turn is made, an apparently disabled car parked on the highway, or the bushes next to the target's gate. The possibilities are endless.

Iranian fundamentalists attempted to do this in Switzerland to assassinate the late Shah of Iran, but the plot was uncovered in the planning stages. The Prime Minister of Spain, Luis Carrero Blanco, was assassinated in December 1973 by a road mine. The Basque extremist separatist group ETA (*Euskadi ta Askatasuna*, or Freedom for the Basque Homeland) observed that Blanco followed a fixed route to mass every day, so they dug a tunnel from a basement apartment to the center of the road. The T-shaped tunnel was 22 feet long and 25 feet across the top (see illustrations on page 59). The ETA placed steel plates in the bottom to help direct the force upwards. They detonated three charges of about 50 pounds each in a ripple pattern, one after the other at 1/10-second intervals. The hood of his car was later recovered from the roof of a five-story building.

There is virtually no defense against this type of attack if the target follows a fixed route. If the target alternates routes to and from his destinations, it is harder to spot a pattern of travel, but it is usually there for his enemy to discern. Almost everyone has a few spots they have to pass on a regular basis, either close to home or the office. For especially difficult targets,

saboteurs employ a roving car bomb, radio-fired, in an auto travelling ahead of the target. Once the target's route is ascertained, the driver parks the wired car in position and remote operators detonate it when the target passes by.

A car bomb of this type killed Ali Hassan Salameh, also known as the Red Prince for his activities as head of the Palestinian terrorist organization, Black September. Created by the PLO as a "deniable" assassination unit, Black September was the most ruthless and effective terrorist squad the Israelis had encountered. It was Salameh who had masterminded the Munich massacre at the 1972 Olympic games. The cold-blooded execution of eleven Israeli athletes in their dormitory at Olympic village shocked the world and persuaded the Israeli government that it had to use the same terror tactics against the killers—particularly Black September—as they were using against Israelis. Salameh was first on their hit list. (As an indicator of the deep-seated and long-term hatred between the Israelis and the Palestinians, Salameh's father had been killed in 1948 by a house bomb planted by the Irgun—a defunct Jewish terrorist group that operated against the British in Palestine prior to and following World War II to establish a separate homeland for Jews.)

The Israelis stalked Salameh and other top Black September leaders for months. Although they succeeded in taking out about a dozen Black September agents, Salameh eluded them. Finally they received word that he had been found and was in a vulnerable position. The Israelis put an assassination plan into action, and they killed a man they believed to be Salameh in Lillehammer, Norway. The dead man bore a remarkable resemblance to the terrorist, but it was not him. They had mistakenly gunned down an unarmed Moroccan waiter, Ahmed Bouchiki, who was

with his pregnant Norwegian wife on the streets of Lillehammer.

Norwegian police arrested six members of the Israeli hit team (all of whom had support roles). They claimed to have been recruited for the assassination by the Mossad (Israeli intelligence). Five were convicted and served time in jail before being quietly paroled and allowed to leave the country. The Israeli government denied any role in Bouchiki's murder, but this debacle effectively shut down the Israeli's European operations for a long time.

The Israelis continued to hunt Salameh, and in 1979 they succeeded in killing him in Beirut, Lebanon, while he was en route to visit his mother. The assassins used a Volkswagen packed with explosives, which blew up as Salameh's Chevrolet station wagon and an accompanying Land Rover filled with his bodyguards passed by. All of the passengers in the Land Rover died immediately, and Salameh died on the operating table at American University Hospital.

With road mines, proper timing is critical. The charge must be detonated *just before* the vehicle passes over it. Reaction time must be checked and rechecked, taking into account many variables, because a fast-moving vehicle can travel many feet in the time between deciding to fire and actually firing, possibly taking it out of the danger zone. A vehicle moving at 5 miles an hour covers 8 feet in 1 second. The 1979 Baader-Meinhof assassination attempt on Alexander Haig, then commanding general of the North Atlantic Treaty Organization (NATO), outside Brussels, Belgium, failed because of timing. Apparently with their personal safety uppermost in mind, the German terrorists set up their firing point a kilometer away. By misjudging the vehicle's speed and their own reaction time, they fired 2.7 seconds too late. The bomb damaged Haig's limousine, but he escaped unhurt.

CULVERT MINE

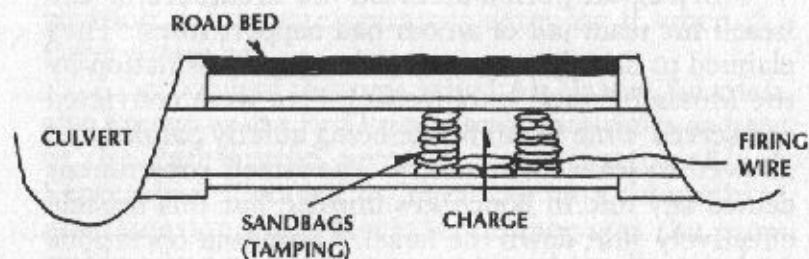
*Culvert Mines*

The Irish Republican Army (IRA) in Northern Ireland has helped to establish culvert mines as deadly assassination tools. Using charges of ANFO (ammonium nitrate/fuel oil) or CO-OP sugar (sodium chlorate and nitrobenzine) weighing an average of 200 pounds, the IRA has wreaked havoc with British army patrols. Outside Warrenpoint, Northern Ireland, the IRA blew a 10-ton Saracen armored car 30 feet into the air, creating a crater almost 20-feet deep and killing 19 British soldiers. As part of their countermeasures to these attacks, the British routinely inspect all culverts before passing over them.

Culvert mines can be extremely useful because they can be installed in much less time than a conventional road mine. Culverts vary in size from about 12 inches in diameter to 4 feet or more. The charge is centered between the mouth of the culvert and the center of the intended lane. If the exact lane is unknown, then placement is determined by measuring from the mouth of the culvert to the line between the lanes.

The charges are stacked directly against the roof of the culvert. If necessary, they can be raised to the

necessary height with sandbags. They are then primed, and the firing wire is reeled out. A common firing wire is two-strand household wire (AWG number 18), which can be bought at electrical contractor suppliers. Both sides are then stacked with sandbags, at least 2 rows wide, to act as tamping, otherwise much of the explosive force escapes out the open ends of the culvert. The firing wire is then carefully reeled (to avoid damaging it) to a concealed firing spot and hooked to the blasting machine or battery. If batteries are used, they must have sufficient power to detonate the charge, especially with multiple charges and primers. They are fired like road mines.

Rules of Mining

- 1) All charges should be sealed against moisture and properly primed. Weak priming can reduce velocity, but a strong booster can increase the velocity of a low-powered explosive such as ANFO. Boosters of 5 to 10 pounds per 40 pounds of main charge are not excessive and will greatly increase the power and velocity of the main explosive. For example, the U.S. Army 40-pound cratering charge contains 30 pounds of ammonium nitrate with a 10-pound TNT booster.
- 2) All spoil (excavated dirt) must be disposed of away from the area of operations. Filling plastic garbage bags with the spoil will aid in its neat disposal and will be useful as tamping. Adding a little water to the tamping bags will increase their efficiency. Do not use too much, however.
- 3) Proper tamping will reduce the amount of necessary explosive by a significant amount. The reason the IRA uses such large charges (average weight of 200 pounds) in their culvert bombs is that most of the explosive force blows out the open ends of the culvert.

- 4) If culverts are used instead of tunnels, make sure explosive placement is done in dry weather or, barring this, in an area where drainage of the ditch water will not be immediately noticed.
- 5) Ideally, the charge should be emplaced within 12 hours of firing.
- 6) Charges should be a minimum of 20 pounds of TNT or its equivalent if the charge is directly under the road surface, increasing by 20 pounds per foot of depth. If the target vehicle is armored, double the charge.
- 7) Check traffic patterns of the target area to discover what types of vehicles routinely use the road. If few or no heavy trucks travel the road, then the charge may be safely emplaced directly under the road surface. The charge should still be in a stoutly constructed box to prevent damage from the weight of passing vehicles.
- 8) All tunnels should be properly stabilized as conditions require to prevent cave-ins (see illustration on page 64).
- 9) Sniper cover should be used in conjunction with the mine whenever possible. They should be concealed and have a good getaway route. If the mine kills the target, the snipers should withdraw quietly.

Suicide Car Bomb

Explosive-laden automobiles have become popular terror weapons over the last few years, especially in the Middle East. The IRA was among the first to make extensive use of car bombs in Northern Ireland, setting them off in shopping centers or near police stations to spread terror. Recently the Islamic Jihad has taken car bombs one step further with the introduction of suicide car bombs. They burst onto the scene in 1983 with the bombing of the U.S. Embassy in Beirut (also

SUICIDE CAR BOMB (SECTIONED VIEW - EXAGGERATED FOR CLARITY)

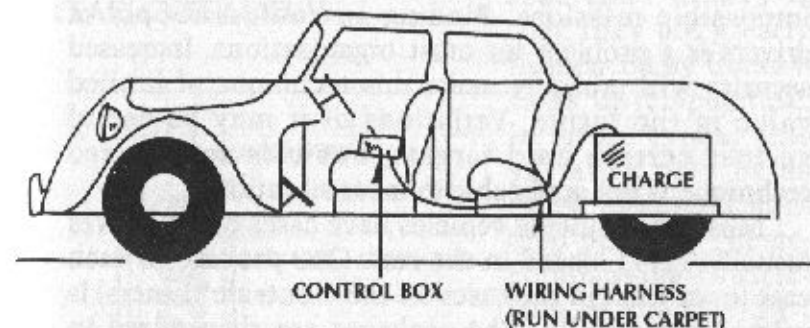

probably the first use of FAE gas-enhanced bombs). A few months later, on October 23, 1983, in the same city, an explosive-laden Mercedes truck crashed through the perimeter of the U.S. Marine compound and exploded inside the headquarters building with such force that the building collapsed and 241 Americans were killed.

Kamikaze car bombs generally carry the equivalent of 2,000 pounds of TNT, but the truck detonated at the marine headquarters had the blast equivalent of 12,000 pounds of TNT. This proves that the explosion was FAE-enhanced because the truck was incapable of carrying a 6-ton load. By way of contrast, most of the unoccupied car bombs left around Beirut contain from 200 to 500 pounds of explosive.

Religious considerations make suicide car bombs viable for the Jihad. Their members believe that dying while killing infidels ensures their place of honor in heaven and the more infidels killed, the greater the honor. This interpretation of the Koran is a bit odd, however, because the Koran has a strict prohibition on

suicide—no matter the reason. For most groups, the suicide attack is the final option to be exercised when all else has failed—if at all. It does allow the use of relatively untrained but highly committed people, saving more valuable operatives for difficult but not impossible missions. Finding an endless supply of drivers is a problem for most organizations. Increased security will probably make this technique of limited value in the future. Variations of it may be useful against certain hard targets, but this specialized technique is not applicable to most situations.

Most Jihad suicide vehicles have cases of explosives (usually TNT) loaded in the rear. One package in each case (or at least in the cases on the 4 outside corners) is primed electrically. The packages are then wired in series, and the wiring harness is run through the backseat or rear of the truck cab to the control box. This box has a 12-volt auto battery, an arming switch, an indicator light, and a trigger switch (household light switches are ideal for this because they are cheap and rugged). If desired, the control box can be set up to draw power from the auto's electrical system.

When the vehicle enters the target area, the driver throws the arming switch. If there is power to the circuit, the indicator lamp lights up. Upon arriving at the target, the driver pulls the trigger switch, detonating the TNT and sending himself immediately to heaven. The trigger should not be too sensitive to shock. Considerable bumping and jarring could cause premature detonation. A timer is sometimes incorporated into the circuit to provide at least the illusion of a safe getaway. The delay should be no longer than 30 seconds, so the target or his security guards are not alerted. Saboteurs should not count on this, however, as security forces will probably riddle any trespasser with bullets before he gets 10 feet away.

LEAD-CREEP DELAY

LEAD-CREEP DELAY

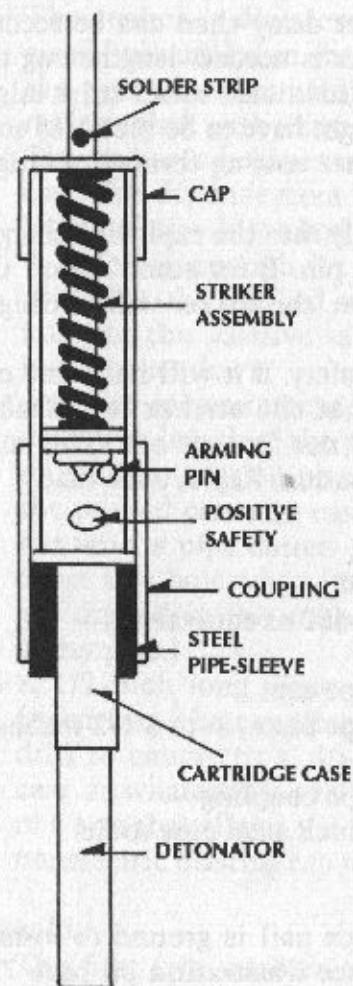

The problem with most, if not all, chemical time delays is that they are greatly influenced by fluctuations in temperature. In some types, this variance may be as much as several hundred percent. The accompanying illustration of the U.S. M-1 chemical delay timing chart illustrates this.

The Soviets and British have used a lead-creep delay since World War II. Its operating principle is based on metals stretching under tension and is much less affected by temperature. A wire under spring tension will cut its way through a metal tab of a given thickness and width. By using different sizes and types of metals in this tab, delays ranging from 15 minutes to several weeks are possible.

Some of the equipment necessary to produce a fuze of this complexity is hard to come by, so an alternative has been developed. Common solder wire is used as a substitute for the lead tab, and 1/2-inch copper pipe parts and various hardware items make up the body. Solder comes in various sizes and metal composition. By experimentation, these instructions will yield a reasonable delay. If a longer delay than can be accomplished with available solder is needed, lengthening the slot in the striker and using additional solder strips might work. The striker power might have to be increased so it can detonate the primer after cutting through multiple solder strips.

- 1) Insert the fuze assembly into the explosive charge.
- 2) Withdraw the arming pin. If for some reason the solder fails at this point, the striker will be caught by the positive safety.
- 3) Remove the positive safety. If it will not come out easily, this means that the striker is probably pressed against it. *Do not force it out.* This may cause premature detonation. Replace the fuze.

Construction

- Three washers (SAE #10)
 - One spring (Century C-680 or equivalent)
 - One 16D duplex nail
 - One 1/2-inch copper pipe cap
 - One 1/2-inch copper pipe piece, 3- to 3 1/2-inches long
 - One 1/2-inch copper pipe coupling
 - One short piece of 1/4-inch steel pipe to fit inside coupling
- 1) The head of the duplex nail is ground to form a firing pin or striker (see illustration on page 72). The flash is cleaned up.
 - 2) A 3/16-inch hole in the center of the copper pipe

cap is drilled or punched.

- 3) Two washers are slipped over the nail, followed by the spring and another washer. Assemble with pipe and cap.
- 4) A dowel is put in the open end of the pipe. This is then placed in the vise and the spring fully compressed. The nail is marked.
- 5) The striker is disassembled and an appropriate-sized hole drilled in the nail (the size depends on the type of solder used). The striker assembly is reassembled, with a small nail in the solder hole.
- 6) The striker is held next to the assembled pipe and cap. The distance from the solder hole down the length of pipe is marked for the arming pin.
- 7) A hole big enough for the arming pin (nail) is drilled at the marked spot on the pipe. Another hole for the positive safety is drilled about 3/8-inch further down.
- 8) Another measurement is taken of the distance down the length of the pipe as in step 6, but with only slight tension on the spring. This is where the primed cartridge case should sit. This spot is cut with a pipe cutter. (Note: The coupling may cover this hole when fitted. If so, matching holes are drilled in the coupling for the arming and safety pins.)
- 9) A 1/2-inch long piece of 1/4-inch steel pipe is fitted into the coupling. This is reamed with a drill to snugly fit a .30-caliber carbine cartridge case or whatever is available. The carbine case is of a size that allows the insertion of a commercial nonelectric blasting cap with no modifications.

Assembly

- 1) The first two washers are placed on the striker nail. They must fit into the copper pipe. This is important because some of the washers in the

LEAD CREEP DELAY - STRIKER ASSEMBLY DETAILS

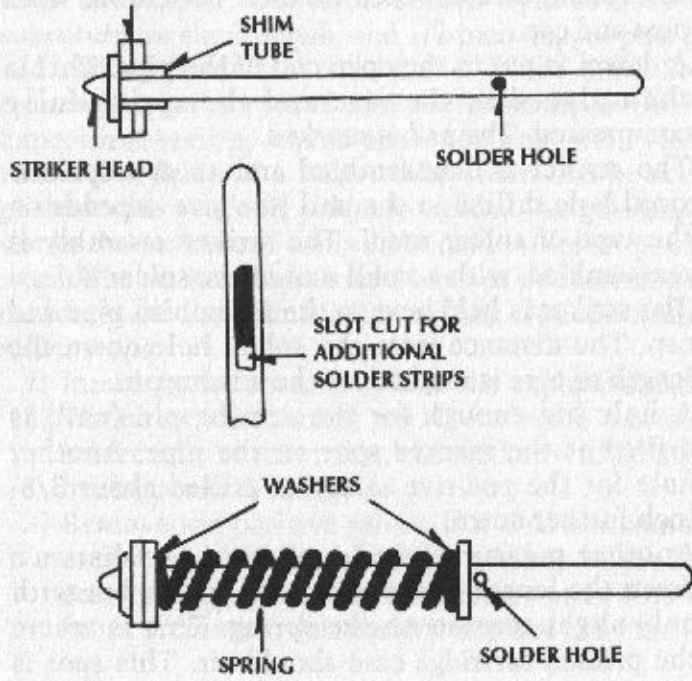

MODIFIED CARTRIDGE/DETONATOR

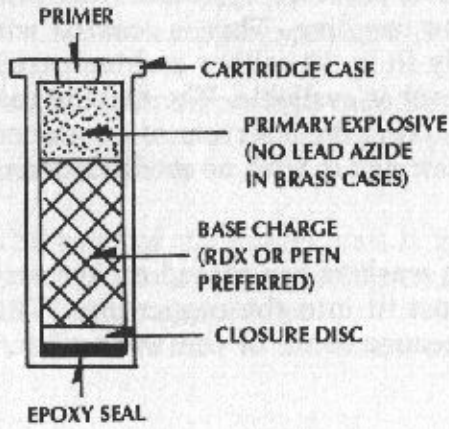

TIME DELAY RELATED TO TEMPERATURE FOR THE M1 DELAY FIRING DEVICES

TEMP (°F)	BLACK		RED		WHITE		GREEN		YELLOW		BLUE		TEMP (°C)
	*OM	**ST	OM	ST	OM	ST	OM	ST	OM	ST	OM	ST	
-25			8.5 HR	3.3 MIN	1.3 DA	2.6 DA	1.2 DA	3.8 DA	8.5 DA	3.0 DA	23 DA	10 DA	-32
0	8 HR	2.5 HR	45 MIN	20 MIN	8 HR	17 HR	8 HR	20 HR	2.0 HR	20 HR	5.0 DA	2.2 DA	-18
+25	36 MIN	16 MIN	25 MIN	11 MIN	5.5 HR	6 HR	2.7 HR	6.0 HR	14 DA	6.0 HR	1.3 DA	14 HR	-4
50	15 MIN	7 MIN	17 MIN	8 MIN	2 HR	2.5 HR	70 MIN	2.5 HR	5.5 HR	2.5 HR	11.5 HR	5 HR	+10
75	9 MIN	4 MIN	15 MIN	7 MIN	1 HR	2.5 HR	30 MIN	2.5 HR	5.5 HR	2.5 HR	5.2 HR	2.3 HR	24
100	5 MIN	2 MIN	8 MIN	3.5 MIN	14 MIN	70 MIN	15 MIN	36 MIN	80 MIN	36 MIN	2.5 MIN	1.1 HR	38
125	4 MIN	1.5 MIN	5 MIN	2 MIN	9 MIN	35 MIN	9 MIN	21 MIN	46 MIN	21 MIN	80 MIN	36 MIN	52
150	3 MIN	1 MIN	4 MIN	1.5 MIN	6 MIN	20 MIN	9 MIN	9 MIN	21 MIN	21 MIN	80 MIN	36 MIN	66

* NOTE: OM—Most likely delay if two devices are used in the same charge. If only a single device is used, this value should be increased approximately 15 percent.

** NOTE: ST—Reasonably safe time. Delays of less than this value should not occur more than one in a thousand.

pack will be oversized. The striker must be centered on the washers so that it will strike the primer. If necessary, the washers can be shimmed with a short piece of tube (see page 72).

- 2) A copper cap is placed on the pipe. Four 1/16-inch holes are drilled in the side, at 90 degree angles through both cap and pipe. The cap is removed and the pipe holes enlarged to 1/8 inch.
- 3) The striker is assembled on the end cap, by placing a small nail through the solder hole. This is fitted on the pipe and the holes in pipe and cap are lined up. A nail is placed in the cap hole and

LEAD-CREEP DELAY

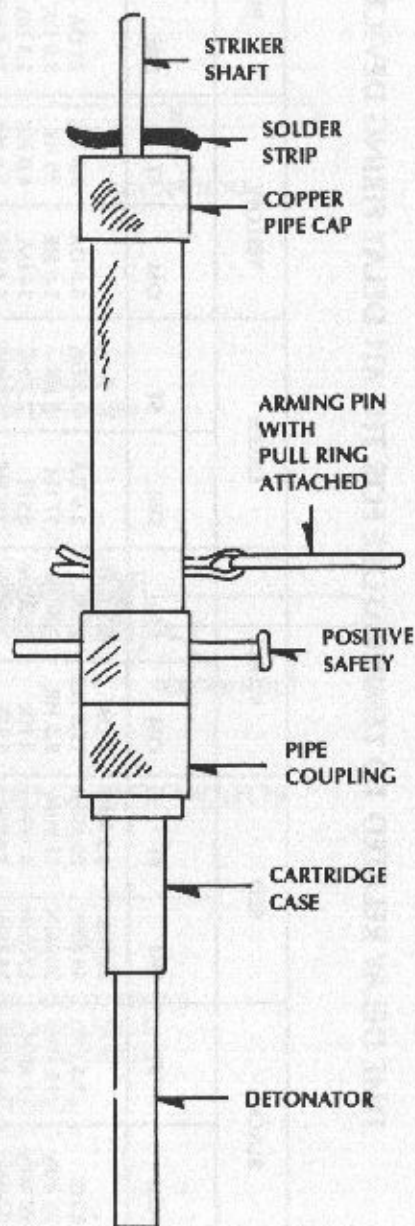

struck sharply with a hammer. This peens the edges of the cap hole down into the pipe to hold them together. This step is repeated with the other three holes. One of the super-adhesive glues is squirted between the pipe and cap as insurance.

- 4) Steps two and three are repeated on the other end with the coupling.
- 5) The cartridge case is inserted in the steel pipe sleeve, and the area around the case is sealed with glue. Light, careful taps with a mallet may be necessary to fully seat the case.
- 6) The pipe sleeve is secured into the coupling with epoxy.
- 7) The detonator is affixed to the cartridge case and glued or taped in place. (Note: The cartridge case can be modified for home-manufactured detonators. The required amount of primary explosive is put into the case and pressed into place. This is repeated with the base charge. A thin disc of plastic or cardboard is placed over this and sealed with epoxy. This assembly should *never* be seated with mallet or hammer taps.) The fuze is now complete.

To use this type of delay for an incendiary charge, the following modifications are recommended.

- 1) The nailhead should not be altered.
- 2) A small vial of sulphuric acid is substituted for the cartridge case in the pipe.
- 3) A cardboard tube of potassium chlorate/sugar mix replaces the detonator. This modification makes the explosive practically silent, except for a low snapping sound when the striker breaks the glass vial.

SYRINGE FUZES

These fuzes are cheaply and easily constructed. They are especially suited for outdoor use because they can be made practically weatherproof. They can be built in two versions: electrical or chemical. Organization of People in Arms (ORPA) insurgents in Guatemala use a variation of the electrical version. The chemical version has a HTH/glycerin ignition system with an inherent 20- to 30-second delay period.

Electrical Version

This syringe fuze is useful as part of a pressure-fuzed land mine because the contacts are sealed inside the syringe, protecting them from moisture. This version is favored by many Third World insurgents because it can be constructed from available materials. ORPA uses it in mines made from cooking pots.

For this version, it is best to use a large syringe of at least 10 cubic centimeters capacity. These are used to apply glue and are commonly found in hobby or handicraft shops. The long tip is snipped off, and the hole reamed with a nail. The lower contact is made from a brass washer 3/8- to 1/2-inch in diameter. A length of electrical wire is soldered to this. The wire is threaded through the hole in the syringe, and the washer is glued into place in the bottom. The upper contact is also a brass washer soldered to another length of wire. A hole, big enough for the wire, is drilled or burned through the tip of the plunger, near the center. The wire is threaded through the hole, and the washer is glued into place on the tip of the plunger. The hole in the tip is then sealed with glue. The surfaces of both contacts must be free of glue so that a good connection may be made. A hole is drilled in the finger rim of the syringe barrel, and the wire from the

SYRINGE FUZE (ELECTRICAL)

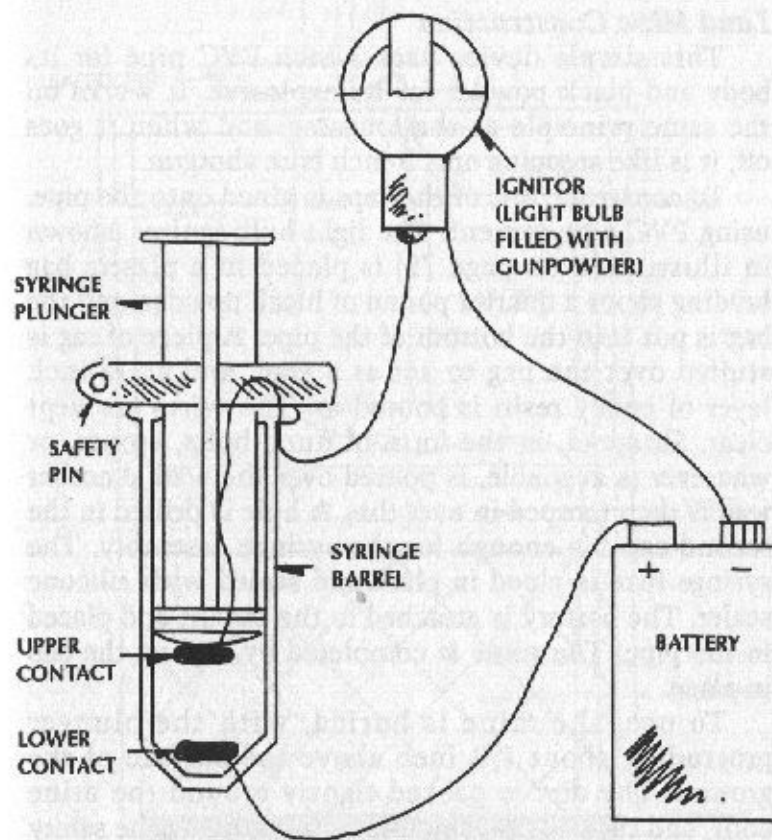

plunger is threaded through it. The syringe is assembled, and the plunger is pushed down until the contacts are about 1/2 inch apart. A hole is drilled horizontally through the plunger at this point for the safety pin. The excess wire is pulled through the hole in the finger rim, and this hole is sealed with glue. There must be enough slack in the wire so that the

plunger can be fully depressed. The fuze is now ready for installation in the mine. The wiring is shown in the circuit drawing (see illustration on page 77).

Land Mine Construction

This simple device uses 3-inch PVC pipe for its body and black powder for its explosive. It works on the same principle as the fougasse, and when it goes off, it is like stepping on a 3-inch bore shotgun.

To construct, one of the caps is glued onto the pipe, using PVC pipe cement. The light-bulb ignitor (shown in illustration on page 79) is placed in a plastic bag holding about a quarter pound of black powder, and the bag is put into the bottom of the pipe. A piece of rag is stuffed over the bag to act as a wad, and a 1/2-inch layer of epoxy resin is poured in. The wires are kept clear. Shrapnel, in the form of nuts, bolts, stones, or whatever is available, is poured over the wad. Another wad is then tamped in over this. A hole is drilled in the second cap big enough for the syringe assembly. The syringe fuze is glued in place and sealed with silicone sealer. The battery is attached to the circuit and placed in the pipe. The mine is completed by sealing the cap in place.

To use, the mine is buried, with the plunger protruding about 1/2 inch above the surface of the ground. The dirt is packed tightly around the mine body, and the hole is camouflaged. Removing the safety pin arms the mine.

Note: If the mine is to be in place for long, or in severe weather, a teaspoonful of petroleum jelly is sometimes melted and poured into the syringe barrel around the plunger. This ensures a watertight seal but does not impede the movement of the plunger. Under ordinary circumstances, the hole through which the lower contact wire is run is not sealed. Doing so

LAND MINE USING SYRINGE FUZE

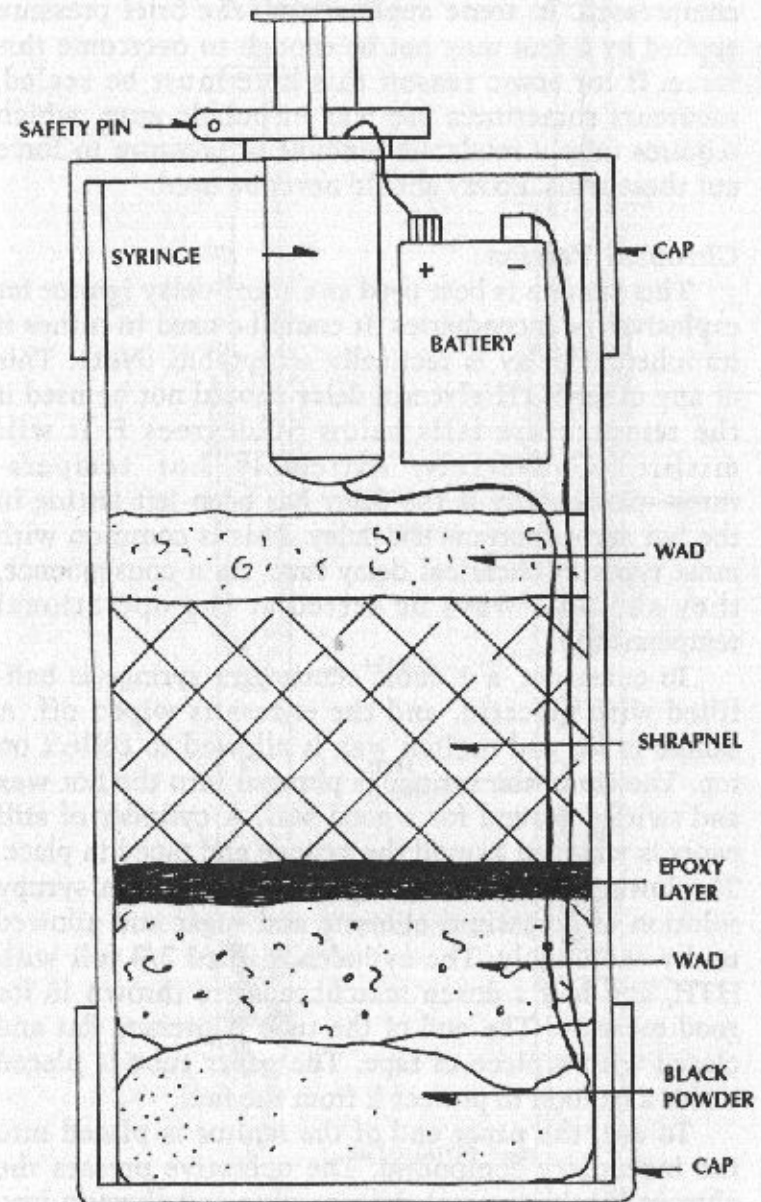

greatly increases the amount of pressure needed to set off the mine, as the air in the syringe will have to be compressed. In some applications, the brief pressure applied by a foot may not be enough to overcome this force. If for some reason this hole must be sealed, saboteurs sometimes use wax or bubble gum, which requires only a moderate amount of pressure to force out these seals. Epoxy should never be used.

Chemical Version

This version is best used as a short-delay ignitor for explosives or incendiaries. It could be used in mines if its inherent delay is tactically acceptable. (Note: This or any other HTH/glycerin delay should not be used if the temperature falls below 50 degrees F. It will misfire. Conversely, extremely hot temperatures—particularly if the delay has been left sitting in the hot sun—shortens the delay. This is common with most types of chemical delay fuze. As a consequence, they should always be tested at the operational temperature.)

To construct, a 1 cubic centimeter syringe is half-filled with glycerin, and the excess is wiped off. A candle is lit, and molten wax is allowed to collect on top. The tip of the syringe is plunged into the hot wax and twirled around for a good seal. A cylinder of stiff paper is wrapped around the syringe and taped in place. The lower part of the syringe is dipped into a syrupy solution of potassium chlorate and sugar and allowed to dry thoroughly. The cylinder is filled 2/3 full with HTH, and half a dozen matchheads are thrown in for good measure. The end of the tube is pressed flat and closed with a piece of tape. The paper tube is placed inside a balloon to protect it from the fuel.

To use, the paper end of the ignitor is placed into the incendiary compound. The operative presses the plunger firmly to expel the wax plug and glycerin into

SYRINGE FUZE (CHEMICAL)

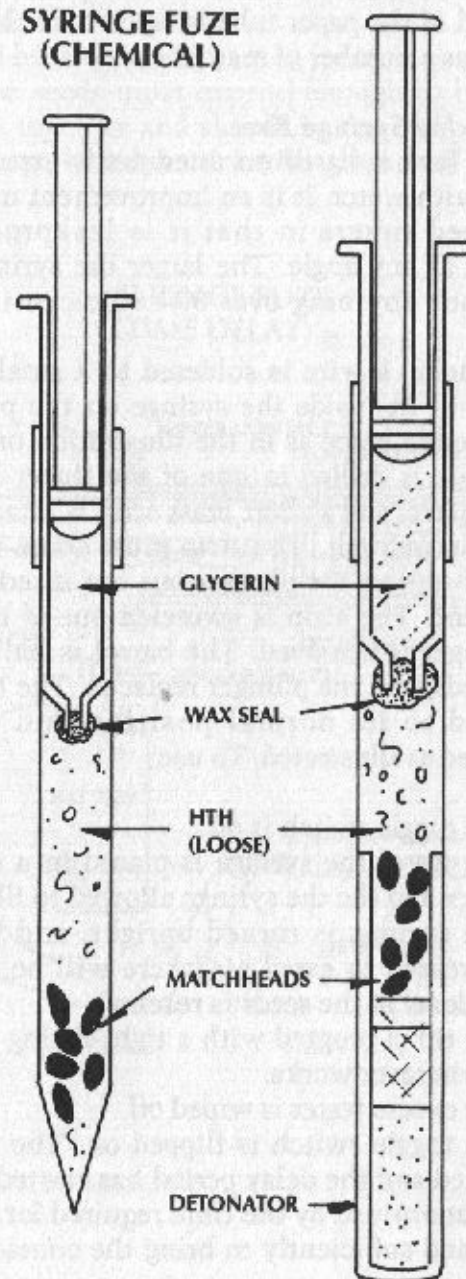

the HTH. If it is to be used in an explosive charge, the open end of the paper tube is taped over the detonator, which has a number of matchheads placed in its recess.

Time-Delay Syringe Fuze

This fuze is based on dried seeds expanding when soaked with water. It is an improvement over previous dried-seed timers in that it is leakproof and will function at any angle. The larger the syringe used the better, but anything over 30 cubic centimeters will work.

To make a wire is soldered to a small brass nut, which will fit inside the syringe on the plunger. It is then glued in place as in the illustration on page 83. A small hole is drilled in one of the finger rims on the syringe barrel and a short brass strip is attached using a small nut and bolt. The strip must come into contact with the nut on the plunger but not interfere with its movement. The strip is swiveled out of the way and the plunger is removed. The barrel is half-filled with dried seeds, and the plunger replaced. The brass strip is returned to its normal position and the wiring completed as illustrated. To use:

- 1) The toggle switch is off.
- 2) The *tip* of the syringe is placed in a container of water and the syringe allowed to fill.
- 3) The syringe is turned upright, and the plunger depressed to expel air (there will be some) until the level of the seeds is reached.
- 4) The tip is plugged with a tight-fitting nail or gum or whatever works.
- 5) The excess water is wiped off.
- 6) The toggle switch is flipped on. The fuze is now armed and the delay period has started. (The delay is determined by the time required for the seeds to expand sufficiently to bring the contacts together.

The delay will not work in temperatures below 32 degrees F.)

Note: The seeds must expand enough to bring the two contacts together and should be tested before use. The plunger can be lubricated with glycerin if it is too tight.

SYRINGE FUZE (TIME DELAY)

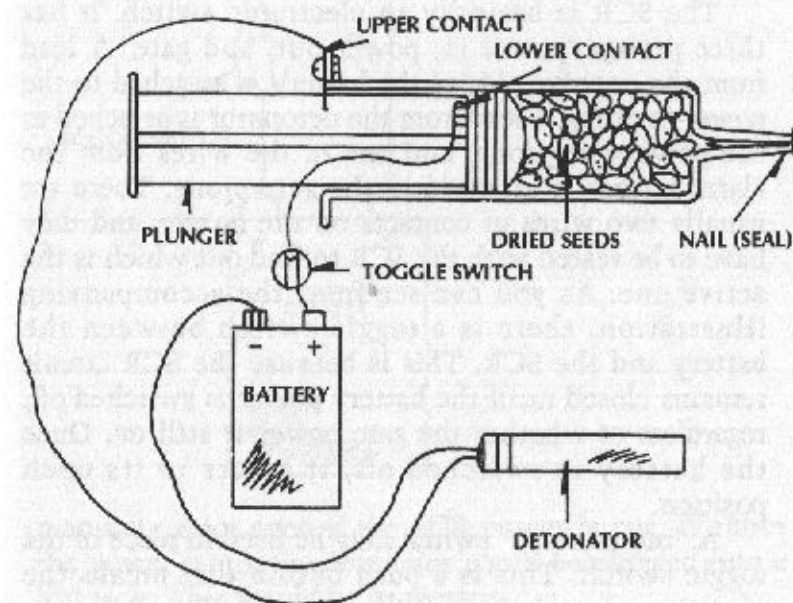

DIGITAL ELECTRONIC TIMERS

With the plethora of electronic timers and alarm watches on the market one would think it would be a simple task to adapt these units as demolition timers. Most of these devices do not put out sufficient energy to their alarm buzzers to reliably detonate an electric blasting cap. But it is not extremely difficult to modify them by using a Silicon-Controlled Rectifier (SCR) switching circuit. The PLO is known to have used timers adapted from a cheap digital alarm watch and a SCR in Lebanon.

The SCR is basically an electronic switch. It has three prongs: power in, power out, and gate. A lead from the positive side of the battery is attached to the power-in prong, a lead from the detonator is attached to the power-out prong, and one of the wires from the alarm buzzer is attached to the gate prong. There are usually two wires or contacts on the buzzer, and they have to be tested with the SCR to find out which is the active one. As you can see from the accompanying illustration, there is a toggle switch between the battery and the SCR. This is because the SCR circuit remains closed until the battery power is switched off, regardless of whether the gate power is still on. Once the battery is switched off, it resets to its open position.

A "momentary" switch may be used in place of the toggle switch. This is a push button that breaks the circuit only while it is depressed. This is more convenient than the toggle switch, but any type of switch will work. (My original test model of this unit used a sliding switch from one of my son's old toy phaser guns.) Also included are a power lamp and detonator jack so the device may be safely field-tested. This is important because most timers must be

DIGITAL ELECTRONIC TIMER

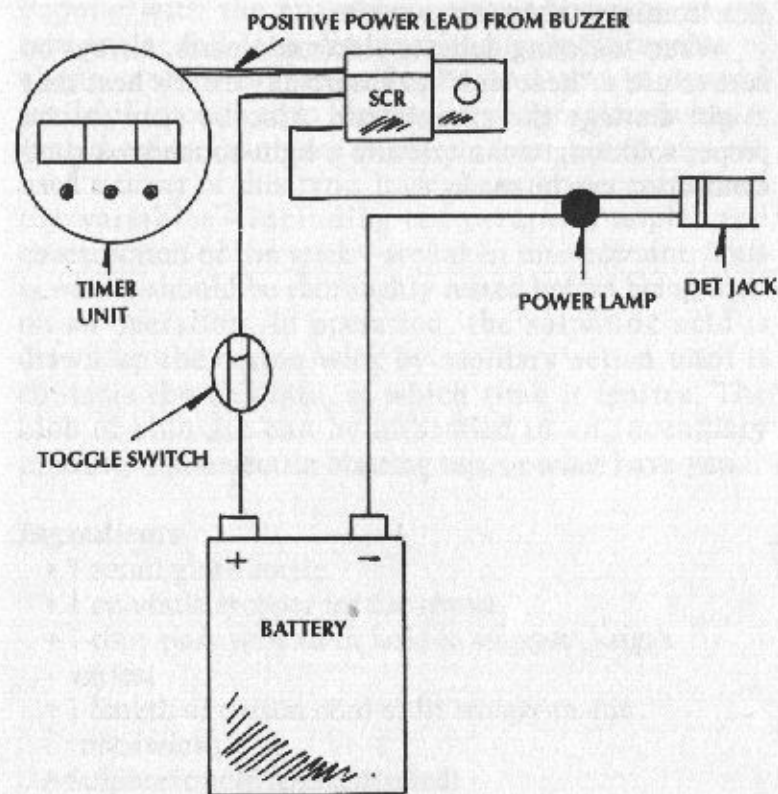

manually reset even if the SCR power is cut. Without the power lamp, the detonator could be plugged into a live jack. This would be dangerous.

Note: For all important demolition projects that use timers, dual timers should be used whenever possible for reliability. Which is worse—spending an extra \$15 or \$20 on a backup timer or having an important project fizzle because of skimping on cost? Always remember that the more complex a fuzing system is,

the more things can go wrong with it. This is not to say that new advances in technology should be ignored, but that they should be thoroughly tested and any potential shortcomings taken into account.

When soldering delicate electronic parts, always be sure to use a "heat sink" to absorb any excess heat that might damage the component. Also be sure to use proper soldering technique and a light touch so a good connection can be made.

CAPILLARY FUZE

The capillary fuze is simple to construct and use. Popular with the anarchists around the turn of the century, it fell into disuse with the introduction of cheap, reliable alarm clocks and the increased availability of electric blasting caps. Speculation has it that the San Francisco Market Street bomb of 1916 used a timer of this type. It can be quite accurate if all the variables—including temperature, angle, and construction of the wick—are taken into account. This is why it should be thoroughly tested before being used on an operation. In operation, the sulphuric acid is drawn up the cotton wick by capillary action until it contacts the chlorate, at which time it ignites. The blob of chlorate can be imbedded in an incendiary mixture, a nonelectric blasting cap, or what have you.

Ingredients

- 1 small glass bottle
- 1 one-hole stopper for the above
- 1 thin glass tube to fit hole in stopper (length varies)
- 1 length of cotton cord to fit snugly inside tube (wick)
- Sulphuric acid (concentrated)
- Chlorate/sugar paste
- Wax

Construction

- 1) The glass tube is carefully pushed into the stopper until about 3/4 inch is exposed at the bottom. Lubricating the tube with glycerin or liquid soap makes this easier.
- 2) The cotton cord is pushed into the glass tube until it protrudes from the far end. Depending on the

size of the tube and cord, a nylon line or copper wire can be attached to pull the wick through. The fit of the wick should be snug but not too tight, or it will act as a plug. About 1 inch should stick out both ends.

- 3) A paste of 50/50 chlorate and sugar mix and a little water is pressed onto the top end of the cord and allowed to dry.
- 4) The bottle is half-filled with concentrated sulphuric acid.
- 5) Coating the inside of the stopper with wax keeps the acid from eating through it.
- 6) The stopper is pressed into the bottle, which arms the fuze and starts the delay.

CAPILLARY FUZE

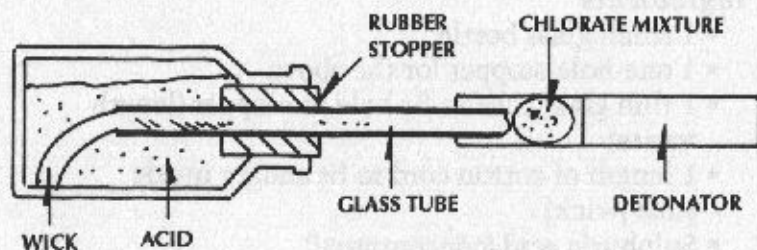

CLOTHESPIN SWITCH

Possibly the most versatile item used in unconventional demolitions is the spring-type clothespin. It can be used as a trigger in at least six different modes: pull/electrical, pull/chemical, pull-release/electrical, pressure/electrical, pressure-release/electrical, and time-delay. There are probably others, but I haven't figured them out yet. The basic electrical switch is made by attaching a metal contact to each of the opposing jaws, which are separated by a wooden wedge. When the wedge is removed, the jaws contact and complete the firing circuit.

Modes of Operation

Pull/electrical. If a wire is attached to the wedge and strung in an appropriate spot to be tripped by passing traffic, it is in the pull mode.

Pull/chemical. This mode departs from the others in that it uses no electricity. To construct this fuze, a small glass vial of sulphuric acid, a 3-inch length of plastic soda straw, potassium chlorate, and sugar are needed.

Mix equal parts of finely ground potassium chlorate and sugar with a little warm water to form a thick dough. Rub this dough through a piece of screen to form small granules similar to gunpowder. Squeeze one end of the straw shut and glue it closed. Pour in a small amount of the chlorate mixture, insert the acid vial, and fill the remainder with more chlorate. Slide this carefully into the open end of a nonelectric blasting cap and secure with tape. The clothespin is arranged so that the soda straw is between the jaws, behind the wedge. It is best if the wedge is flat on the end to make the jaws snap shut.

When the wedge is removed, the jaws crush the

acid vial. The sulphuric acid ignites the chlorate mix, which in turn ignites the blasting cap. The clothespin must have enough strength to crush the glass vial.

Pull-release/electrical. This is accomplished by securing the clothespin to a rigid base, attaching a nylon line to the free jaw, stretching it tightly across the avenue of approach and securing to another rigid structure. The wedge is then withdrawn. It will fire when the line is broken. (Note: This circuit can also be used as a time delay. The line is run through the center of a candle next to the wick. When the candle burns down it will melt the line, completing the circuit.)

Pressure/electrical. To install in the pressure mode, a small hole is drilled in the opposite end of the clothespin from the jaws. Glue a small, clean nut, which has a wire soldered to it, over the hole. A metal contact is glued to the opposite side. A bolt of the appropriate size is threaded into the nut. The gap may be increased or decreased to vary sensitivity. Pressure on the screw will push it down onto the other contact, completing the circuit.

Pressure-release/electrical. If a weight is placed on the opposite end of the clothespin and the wedge removed, it is in the pressure-release mode. It will fire when the weight is removed.

Time-delay. Another method of time delay can be accomplished by wrapping the far end of the clothespin with several turns of solder wire. When the wedge is removed, the solder will stretch until the jaws contact, completing the circuit. The delay will vary according to the temperature and the number and tightness of the wraps. Always test first.

PULL (WITH BASIC CIRCUIT)

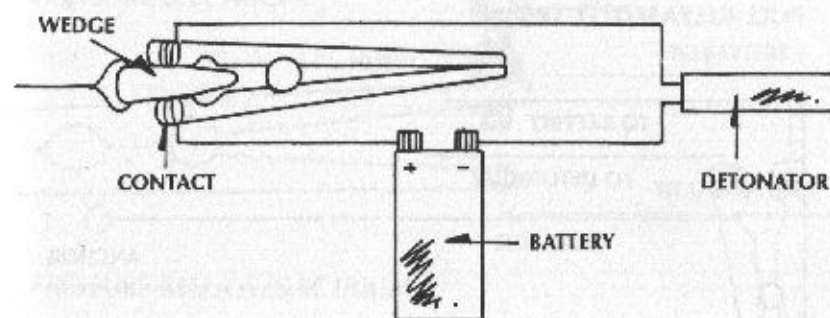

PULL/CHEMICAL

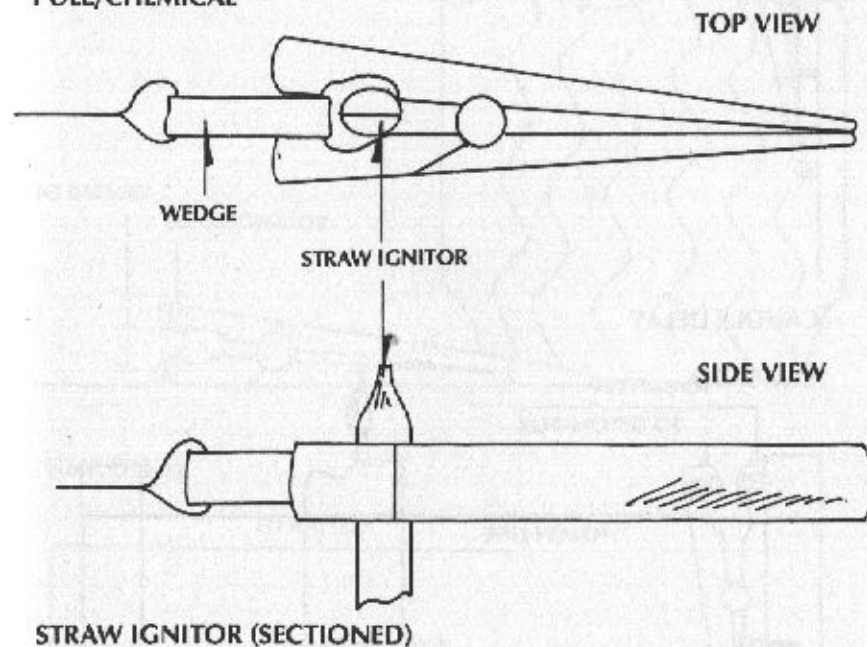

STRAW IGNITOR (SECTIONED)

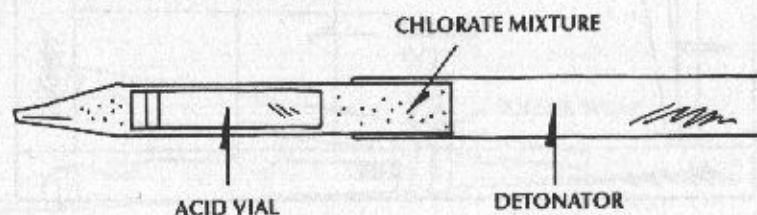

PULL-RELEASE/ELECTRICAL

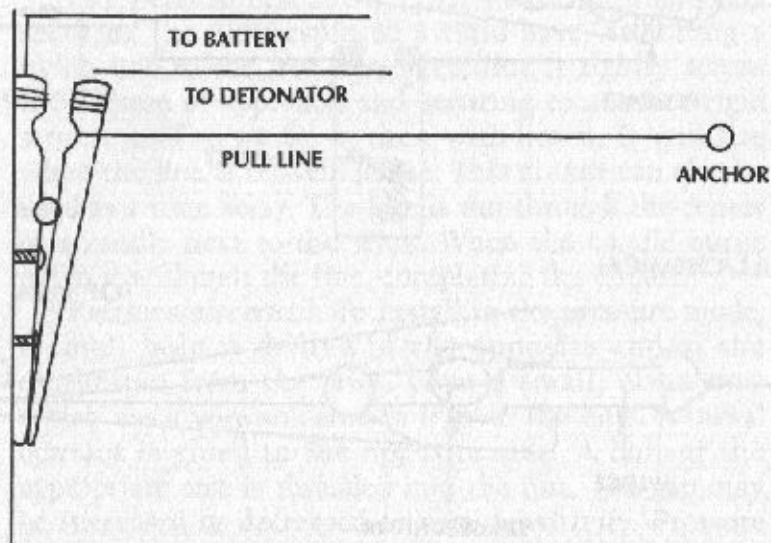

CANDLE DELAY

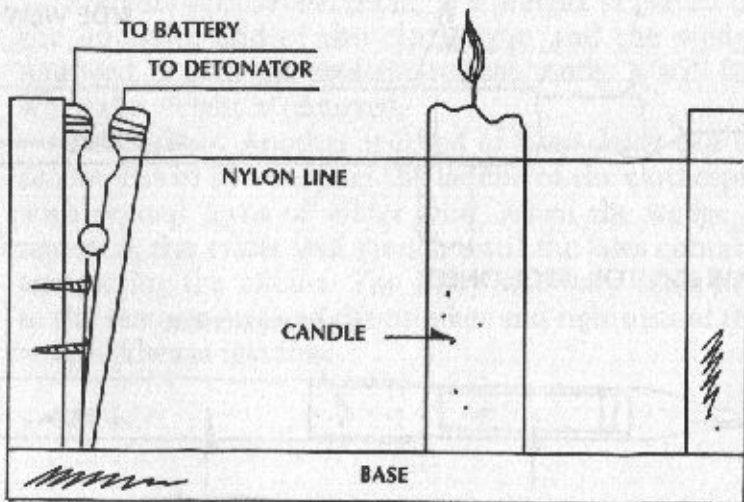

PRESSURE/ELECTRICAL

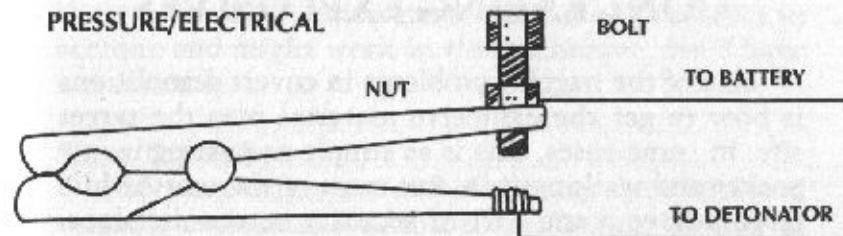

PRESSURE-RELEASE/ELECTRICAL

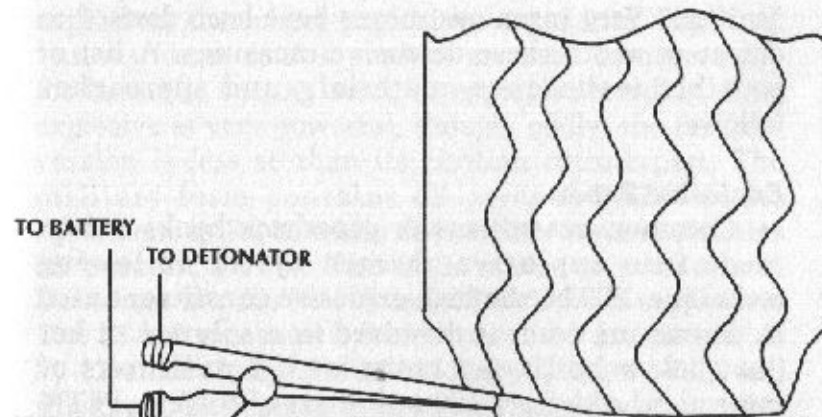

TIME DELAY

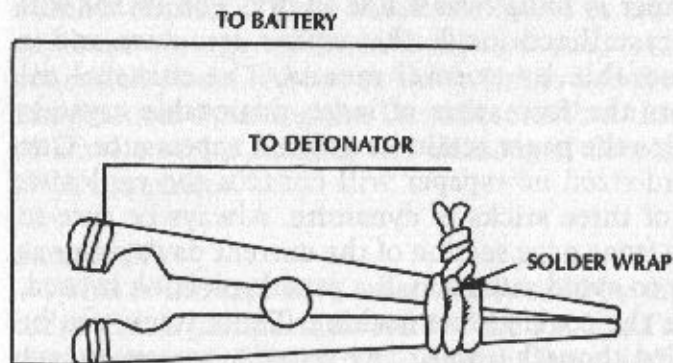

CONCEALING EXPLOSIVES

One of the nagging problems in covert demolitions is how to get the explosive material into the target site. In some cases, this is as simple as putting it in a pocket and walking it in. But most of the worthwhile targets have some sort of security screen in place. This can range from a cursory bag inspection by a security guard to sophisticated X-ray scans or the use of a neutron vapor analysis (NVA) explosives "sniffer." Very ingenious means have been devised to defeat or avoid these defensive measures. A list of possible techniques, materials, and approaches follows.

Explosive Paper

Common newspapers or paperback books can be made into explosive charges by the following technique. PETN, the high-explosive constituent used in detonating cord, is dissolved in a solution of hot (just below boiling) acetone with 2 milliliters of mineral oil added per 100 milliliters of solvent. PETN is added to the solution until no more will dissolve. The newspaper is unfolded and soaked in a shallow pan containing the above solution until it cools. The newspaper is hung over a line to dry. The PETN will have crystallized inside the paper's structure and is undetectable by normal means. The mineral oil prevents the formation of large, noticeable crystals and helps the paper retain its original appearance. One standard-sized newspaper will contain the explosive power of three sticks of dynamite. Always be sure to use the front-page section of the current day's paper as a cover to avoid attention. If a paperback book is used, remove the cover before soaking. These items can be smuggled through almost any security screen, except

those using NVA equipment. RDX is also soluble in acetone and might work in this technique, but I have not tested it.

Sheet Explosives

Sheet explosives are one of the most powerful and versatile explosives available today. During World War II, the Germans used Nipolit, an early form of sheet explosive, but it wasn't until the early 1960s when Du Pont perfected Detasheet, the first reliable sheet explosive, that sheet explosives came into wide use. Various forms of this product are used commercially for boosters, cutting steel, or explosive welding. This explosive is very powerful, though, oddly, the military version is less so than its civilian counterpart. The military form contains 63 percent PETN or its equivalent in RDX, while the civilian variant contains 85 percent PETN. The U.S. military versions of Detasheet are the M-118 and M-186 sheet explosives. The M-118 measures 1/4 inch thick by 3 inches wide by 12 inches long. The M-186 has the same width and thickness, but comes in a 50-foot roll. They are olive green, while the commercial types are usually orange or white. Because of their size and form, sheet explosives lend themselves to concealment in any number of places. They have been found in envelopes, suitcase linings, electronic equipment, and other concealed places. About the only limits are the user's imagination. Spraying the Detasheet with a thin layer of acrylic sealer reduces the chances of detection by NVA equipment.

Semtex H

This is the explosive most widely used by terrorists today. It is a particular favorite of the Popular Front for the Liberation of Palestine, General Command (PFLP-GC) in their attacks on civilian airliners. A

Czechoslovakian product, Semtex H is composed of 44.5 percent RDX, 44.5 percent PETN, and 11 percent vegetable oil plasticizer. Although both RDX and PETN crystals are white, Semtex H is bright orange. In a recent program on the bombing of Pan Am flight 103 over Lockerbie, Scotland, in December 1988, ABC News referred to Semtex H as a state-of-the-art plastic explosive. Actually it is World War II technology, being roughly equivalent in content to a Japanese plastic explosive of that era.

While undeniably powerful and possessing all the qualities one would expect of a plastic explosive, Semtex has one serious flaw—a tendency to exude the vegetable oil plasticizer at elevated temperatures. In a recent case at London's Heathrow Airport, an alert security officer noticed an oily stain on a passenger's bag and suspected it was from Semtex. Security officials searched the bag, found the bomb set to go off

SEMTEX H PLASTIC EXPLOSIVE



Semtex is bright orange and is wrapped in a brown wax paper-like material. Weight: 1 kilogram (estimated).

when the plane was in flight, and defused it. The unwitting bomb courier, a pregnant Irish woman, was attempting to board an El Al flight to Europe and had passed all of El Al's excellent security procedures. Even with this shortcoming, Semtex has one great advantage for terrorists—the vegetable oil greatly reduces the vapor pressure (smell) of the explosive, making it much harder to spot using standard NVA explosives detectors.

Composition C-4

This is the standard-issue plastic explosive used by the U.S. military. I received most of my early demo training in the army, which spoiled me for C-4. It retains its moldability over a wider range of temperatures, doesn't exude liquid (as does Semtex), and is pound-for-pound the most powerful explosive in common use. Its power, stability, and versatility are unequalled. C-4 is in such demand and so well thought of that Muammar al-Quaddafi paid Edwin Wilson an exorbitant sum for 20 tons, even though he could get all of the Semtex he wanted on the open market for a much-lower price.

With a few simple modifications, C-4 becomes even more versatile. If you mix 7 fluid ounces of mineral oil with a 1 1/4 pound bar, you get an excellent paste explosive, roughly equivalent in power to TNT, and capable of sticking to almost anything. Sealed inside flat plastic bags, this mix can be secreted in any number of useful spots (soft-sided luggage, for instance).

One note of caution should be mentioned. With C-4 or any plastic explosive, the user should avoid mashing it when loading it into special devices or preparing charges. The sectional density of an explosive has a direct bearing on its power and velocity. The explosive packages are press-loaded to their optimum density for highest performance. This is not to say that they will

COMPOSITION C-4 PLASTIC EXPLOSIVE

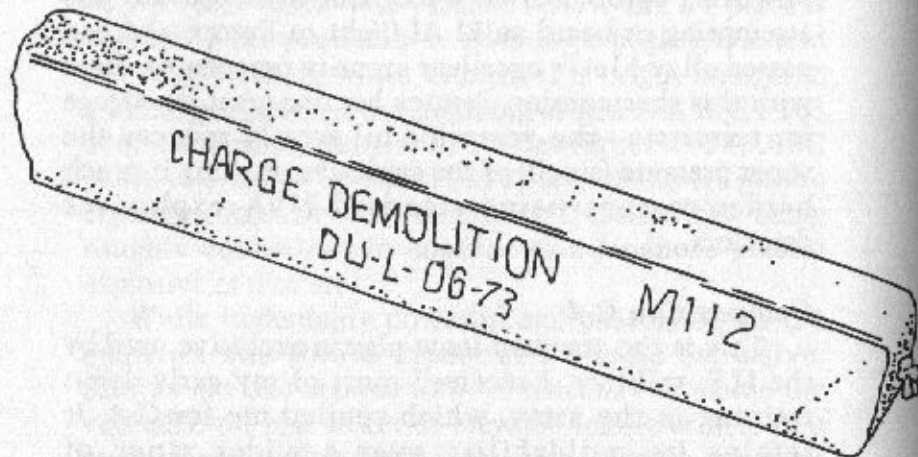

Older blocks of C-4 are dull gray and packed in a clear Mylar film container. Recent blocks of C-4 are white and packed in an olive-drab container. Each block has an adhesive strip on the back. Weight: 1.25 pounds.

M-118 SHEET EXPLOSIVE

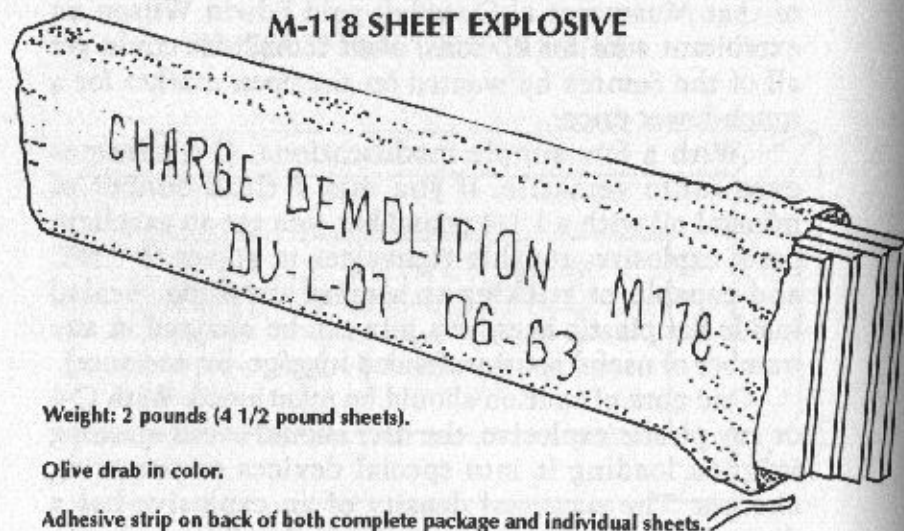

Weight: 2 pounds (4 1/2 pound sheets).

Olive drab in color.

Adhesive strip on back of both complete package and individual sheets.

not explode when used in this manner, but they will not utilize their full explosive potential.

Sometimes commercial number 8 blasting caps will not detonate C-4, which was formulated for use with the more powerful J-2 military caps. In this case, two number 8s can be taped together, or some of its RDX can be extracted to use as a booster. To do this, a small lump (about 1 ounce) of C-4 is put into a cup of gasoline. The lump can be broken apart with a fork. Let it sit for an hour or so. The RDX should have separated from the plastic, which is soluble in gasoline, to form a white powder at the bottom of the container. This residue is filtered out of the gasoline and washed on the filter with a little more gas. Letting it sit overnight will evaporate any residual gas. Find a tube that will snugly fit the blasting cap and hammer one end closed. One or two grams of the RDX is pressed into the bottom of the tube, and the blasting cap is inserted and taped into place.

Liquid Explosives

Hiding places for liquid explosives are innumerable. Liquor bottles, cologne or aftershave lotion, and bottled soft drinks are just a few of the potential spots. A few of the useful liquid explosives are: 70 percent nitroglycerin and 30 percent acetone; 95 percent nitromethane and 5 percent ammonium hydroxide; 75 percent concentrated (90 percent) hydrogen peroxide and 25 percent glycerin (very touchy stuff). A common problem with all of these mixtures (except the hydrogen peroxide/glycerin, which does not contain an NO_2 group in its chemical makeup) is that their odor is easily detected by NVA detectors. Unfortunately, the hydrogen peroxide/glycerin mixture is also the most volatile of the three.

If NVA detectors are in use, the following technique may get the bottle past them. The bottle must be

perfectly sealed, and any spilled explosive carefully washed off the outside. The bottle should be stored in a bag of activated charcoal for at least one week prior to its use and the charcoal changed at least twice during this time. This should absorb any residual vapors. When using any liquid explosives, always be sure the detonator is centered in the liquid to reduce the chance of low-order detonation.

Cast Explosives

Terrorists have cast explosives into various items, such as statuettes and toys, to avoid detection. Explosives have also been cast into building bricks and painted to resemble the real thing. As you can guess, it is a simple matter to smuggle these into construction sites. Imagine the effect if several strategically placed bricks were replaced with explosive ones. A standard-sized brick contains 2 1/2 to 3 pounds of explosive material. These usually carry some distinctive yet unobtrusive marking for ready identification. (While we're on the subject of construction sites, the bottom layer of a cinder-block wall may have explosives hidden in the two cavities of each block. They have to be protected from the concrete that is usually poured in over them, and they are usually readily accessible and identifiable for priming.)

TNT is the most commonly used explosive because of its relatively low melting point, followed by Pentolite (PETN/TNT) that is removed from commercial booster charges (usually Du Pont HDPs). Both of these can be melted in a double boiler and poured into molds. If Pentolite is used, it must be stirred constantly to prevent the PETN from separating.

As the TNT cools and contracts, a crust may form on the surface of the explosive in the mold. This crust or film should be carefully broken, and more explosive

poured in to fill the void. *Use great caution during all casting operations, as molten TNT is as sensitive to shock as nitroglycerin.* Before the explosive has cooled completely, a cap well should form in its center. If necessary, this may be drilled after cooling, using a hand drill and going very slowly to avoid building up excessive heat from friction.

The TNT dust that comes from the drilling should be avoided because it is toxic to the lungs, skin, and eyes. This hole is plugged with cotton and its opening camouflaged with a thin layer of putty. This putty is easily removed at the time of use. When the casting has cooled completely, the mold is removed. The cast item may be painted with acrylic or enamel paint, both as a disguise and to mask its smell.

Note: Most TNT blocks are made of pressed explosive, which can be reliably detonated by a commercial number 8 blasting cap. Cast TNT has a much higher density than the pressed block and is therefore more powerful but also harder to detonate. Cast TNT requires the equivalent of a military J-2 blasting cap or a booster. Cast Pentolite is sensitive to a number 8 blasting cap.

NITRO NOTES

The synthesis of nitroglycerin is a fairly simple process that has been covered in several other books and will not be repeated here. One of the problems with most of these accounts is that they leave you with a batch of highly sensitive explosive and no idea of how to deal with it. I made my first batch of nitro when I was 16. Although my experiment was successful and I managed to transport it to a safe area for detonation, in retrospect I was quite lucky to have made it out of my teenage years alive. In many cases (like mine), home-brewed nitro is full of occluded water and other impurities that can increase sensitivity.

Nitro is a valuable explosive because it is easy to acquire the basic materials at a reasonable cost. However, its most notorious quality—extreme sensitivity—makes it difficult to work with. This problem can be overcome in several ways, including adding acetone or blasting gelatin. Adding acetone (a common solvent) to liquid nitro until the mix is 70 percent nitro and 30 percent acetone yields a much more shock-resistant liquid that can still be reliably detonated by a no. 8 blasting cap. It is not necessary to separate the two liquids before detonation. Although a sharp jolt might cause nitro to explode, this is generally a low-order detonation and doesn't utilize the full explosive power of the material. As with all explosives, a strong detonator works best.

The other solution is to convert the nitro to blasting gelatin, a rubbery, solid material suitable for all types of blasting. It can be cast into a myriad of charge containers. This method produces a stable, high-density gel that was originally developed for commercial shaped charges. To prepare, cool 90 parts, by weight, of nitro to 4 degrees C (39.2 degrees F) in a

cold-water bath. Stir in 9 parts nitrocellulose (finely ground single-base gunpowder may be used) and 1 part finely powdered chalk, with the minimum agitation necessary for a thorough mix. Pour this into the desired container and warm it in a water bath until the mixture gels. (Refer to U.S. patent 2,595,960 if you would like details on its performance in shaped charges.) Its detonating velocity is 7,600 to 7,800 meters per second.

LIMPETRY

Limpetry involves attaching explosive charges to the hulls of ships in order to blow them up. Persons contemplating the sinking of a seacraft must consider a number of variables, including size, construction of the hull (steel, wood, fiberglass, ferroconcrete, and so forth) the nature of the cargo, and the type of damage required. An exploding charge tends to follow the path of least resistance. Since water cannot be compressed, the path in this case is through the ship's hull. Therefore, it follows that much more damage can be caused by an underwater explosive charge than by the same charge in open air.

The standard magnetic limpet used by Allied underground forces and special warfare groups in World War II carried 2 1/2 pounds of high explosive and proved effective against merchant shipping vessels. Two or 3 were attached to the outside of each ship near the boilers or engine room. Each was capable of opening a 5-foot square hole in the hull and effectively sinking the ship. These were less effective against warships, as an armored hull is much more difficult to pierce. When the French DGSE sank the Greenpeace ship *Rainbow Warrior* in 1985, they used 2 charges of about 5 kilograms each. The ship was a total loss.

The method used to attach the explosive to the hull depends on the type of material from which the ship is built. Obviously, magnets would be good for metal hulls, but the barnacles and other slime that coat a hull that has been in the water for a long time may keep them from working. Toward the end of World War II, OSS scientists perfected a device, code named "Pin Up," that fired a hardened steel nail into the hull to secure the limpet. It worked equally well on wood or steel hulls. A similar device could be fashioned from a

LIMPETRY SINKING OF THE *RAINBOW WARRIOR* (EXAGGERATED FOR CLARITY)

END VIEW (SECTIONED)

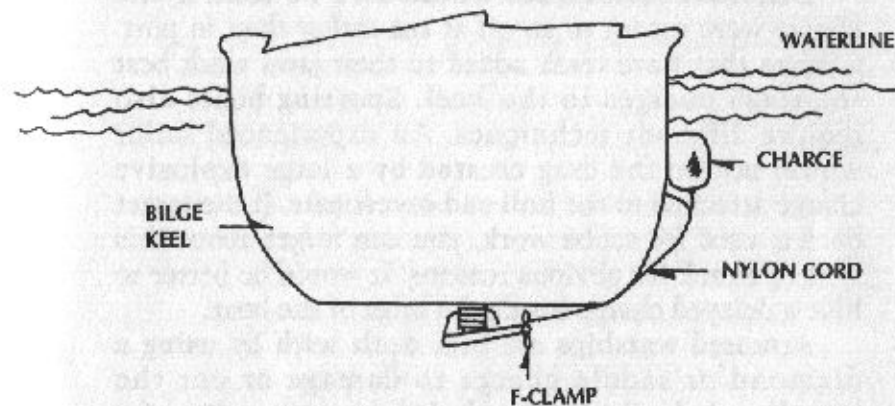

SIDE VIEW OF PROPELLER-SHAFT BOMB

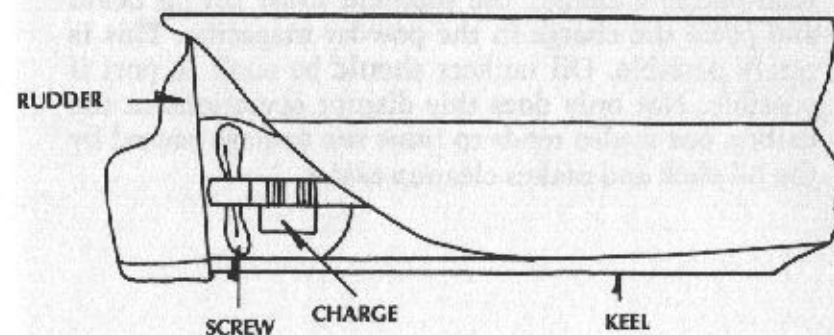

commercially available nailgun cartridge that works on the same principle. The DGSE used F-clamps attached to the keel of the *Rainbow Warrior* to secure their charges. A rope attached to the clamp was tied to the charge, which was equipped with a floatation device. This allowed the charge to float up against the side of the ship to a more vulnerable spot than the keel.

Different techniques would also be used if the charge were meant to go off at sea rather than in port. Clamps that have teeth added to their jaws work best to attach charges to the keel. Sporting boats also require different techniques. An experienced sailor would notice the drag created by a large explosive charge attached to the hull and investigate. If the target boat is used for scuba work, you can forget about this type of attack for obvious reasons. It would be better to hide a delayed charge inside the bilge of the boat.

Armored warships are best dealt with by using a diamond or saddle charge to damage or cut the propeller shaft. Custom-made Velcro straps are useful for attaching charges around propeller shafts, where the armor is usually thinnest. To destroy a warship with a man-portable charge, the saboteur must get on board and place the charge in the powder magazine. This is rarely possible. Oil tankers should be sunk in port if possible. Not only does this disrupt operations in the harbor, but it also tends to limit the damage caused by the oil slick and makes cleanup easier.

The Anarchist Arsenal offers a fresh approach to the explosives book genre, taking up where the more common improvised explosives handbooks—which are essentially reprints of military manuals—leave off. The author, a former military explosives specialist and avowed powder monkey, has read all the others; he wrote this book to fill in the gaps.

Some of the innovative new devices in this book have never been seen in print, and every one of them works. Diagrams, formulas, and instructions for the ultimate molotov cocktail, lunch bag incendiaries, FAEs, syringe fuzes, digital electronic timers, contact explosives, fire bombs...*The Anarchist Arsenal* leaves nothing out.

You'll find detailed instructions on construction and installation of advanced and improvised explosives, as well as informative, intriguing glimpses into the world of terrorism and counterterrorism. And you'll get a close-up look at the favorite terror tools of anarchists, saboteurs, and antiterrorist professionals from around the world, including the IRA, PLO, Mossad, Basque ETA, and SAS.

A PALADIN PRESS BOOK

ISBN 0-87364-580-4

ISBN 0-87364-580-4



9 780873 645805